

## Table of Contents

<b>Introduction</b>	<b>4</b>
<b>Instrument Cluster</b>	<b>12</b>
Warning lights and chimes	12
Gauges	17
<b>Entertainment Systems</b>	<b>19</b>
AM/FM stereo with CD/MP3	19
Auxiliary input jack (Line in)	27
USB port	29
Satellite radio information	32
SYNC®	35
<b>Climate Controls</b>	<b>36</b>
Manual heating and air conditioning	36
Rear window defroster	38
<b>Lights</b>	<b>39</b>
Headlamps	39
Turn signal control	42
Bulb replacement	43
<b>Driver Controls</b>	<b>48</b>
Windshield wiper/washer control	48
Steering wheel adjustment	49
Power windows	52
Mirrors	53
Speed control	54
Moon roof	59
Message center	60
<b>Locks and Security</b>	<b>68</b>
Keys	68
Locks	68
Anti-theft system	78

## Table of Contents

<b>Seating and Safety Restraints</b>	<b>81</b>
Seating	81
Safety restraints	89
Airbags	102
Child restraints	118
<b>Tires, Wheels and Loading</b>	<b>138</b>
Tire information	138
Tire inflation	140
Tire Pressure Monitoring System (TPMS)	152
Vehicle loading	157
Trailer towing	161
Recreational towing	162
<b>Driving</b>	<b>163</b>
Starting	163
Brakes	168
Traction Control™	170
AdvanceTrac®	172
Transmission operation	177
<b>Roadside Emergencies</b>	<b>183</b>
Getting roadside assistance	183
Hazard flasher control	185
Fuel pump shut-off switch	185
Fuses and relays	186
Changing tires	192
Wheel lug nut torque	197
Jump starting	198
Wrecker towing	203
<b>Customer Assistance</b>	<b>205</b>
Reporting safety defects (U.S. only)	211
Reporting safety defects (Canada only)	212

## Table of Contents

<b>Cleaning</b>	<b>213</b>
<b>Maintenance and Specifications</b>	<b>220</b>
Engine compartment	223
Engine oil	225
Battery	227
Engine coolant	229
Fuel information	235
Air filter(s)	249
Part numbers	251
Maintenance product specifications and capacities	252
Engine data	254
<b>Accessories</b>	<b>258</b>
<b>Index</b>	<b>260</b>

All rights reserved. Reproduction by any means, electronic or mechanical including photocopying, recording or by any information storage and retrieval system or translation in whole or part is not permitted without written authorization from Ford Motor Company. Ford may change the contents without notice and without incurring obligation.

Copyright © 2008 Ford Motor Company

<https://www.MyCarManual.com>

## Introduction

### CONGRATULATIONS

Congratulations on acquiring your new Ford. Please take the time to get well acquainted with your vehicle by reading this handbook. The more you know and understand about your vehicle, the greater the safety and pleasure you will derive from driving it.

For more information on Ford Motor Company and its products visit the following website:

- In the United States: [www.ford.com](http://www.ford.com)
- In Canada: [www.ford.ca](http://www.ford.ca)
- In Australia: [www.ford.com.au](http://www.ford.com.au)
- In Mexico: [www.ford.com.mx](http://www.ford.com.mx)

Additional owner information is given in separate publications.

This *Owner's Guide* describes every option and model variant available and therefore some of the items covered may not apply to your particular vehicle. Furthermore, due to printing cycles it may describe options before they are generally available.

Remember to pass on this *Owner's Guide* when reselling the vehicle. It is an integral part of the vehicle.



**WARNING: Fuel pump shut-off switch:** In the event of an accident the safety switch will automatically cut off the fuel supply to the engine. The switch can also be activated through sudden vibration (e.g. collision when parking). To reset the switch, refer to the *Fuel pump shut-off switch* in the *Roadside Emergencies* chapter.

### SAFETY AND ENVIRONMENT PROTECTION

#### **Warning symbols in this guide**

How can you reduce the risk of personal injury to yourself or others? In this guide, answers to such questions are contained in comments highlighted by the warning triangle symbol. These comments should be read and observed.

#### **Warning symbols on your vehicle**

When you see this symbol, it is imperative that you consult the relevant section of this guide before touching or attempting adjustment of any kind.



#### **Protecting the environment**

We must all play our part in protecting the environment. Correct vehicle usage and the authorized disposal of waste, cleaning and lubrication materials are significant steps towards this aim. Information in this respect is highlighted in this guide with the tree symbol.



#### **CALIFORNIA Proposition 65 Warning**

 **WARNING:** Engine exhaust, some of its constituents, and certain vehicle components contain or emit chemicals known to the State of California to cause cancer and birth defects or other reproductive harm. In addition, certain fluids contained in vehicles and certain products of component wear contain or emit chemicals known to the State of California to cause cancer and birth defects or other reproductive harm.

## Introduction

### PERCHLORATE MATERIAL

Certain components of this vehicle such as airbag modules, seat belt pretensioners, and button cell batteries may contain Perchlorate Material – Special handling may apply for service or vehicle end of life disposal. See [www.dtsc.ca.gov/hazardouswaste/perchlorate](http://www.dtsc.ca.gov/hazardouswaste/perchlorate).

### BREAKING-IN YOUR VEHICLE

Your vehicle does not need an extensive break-in. Try not to drive continuously at the same speed for the first 1,000 miles (1,600 km) of new vehicle operation. Vary your speed frequently in order to give the moving parts a chance to break in.

Do not add friction modifier compounds or special break-in oils since these additives may prevent piston ring seating. See *Engine oil* in the *Maintenance and Specifications* chapter for more information on oil usage.

### SPECIAL NOTICES

#### New Vehicle Limited Warranty

For a detailed description of what is covered and what is not covered by your vehicle's New Vehicle Limited Warranty, refer to the *Warranty Guide/Customer Information Guide* that is provided to you along with your *Owner's Guide*.

#### Special instructions

For your added safety, your vehicle is fitted with sophisticated electronic controls.



**WARNING:** Please read the section *Airbag Supplemental Restraint System (SRS)* in the *Seating and Safety Restraints* chapter. Failure to follow the specific warnings and instructions could result in personal injury.



**WARNING:** Front seat mounted rear-facing child or infant seats should **NEVER** be placed in front of an active passenger airbag.

## Introduction

### **Service Data Recording**

Service data recorders in your vehicle are capable of collecting and storing diagnostic information about your vehicle. This potentially includes information about the performance or status of various systems and modules in the vehicle, such as engine, throttle, steering or brake systems. In order to properly diagnose and service your vehicle, Ford Motor Company, Ford of Canada, and service and repair facilities may access vehicle diagnostic information through a direct connection to your vehicle when diagnosing or servicing your vehicle. For U.S. only (if equipped), if you choose to use the SYNC® Vehicle Health Report, you consent that certain diagnostic information may also be accessed electronically by Ford Motor Company and Ford authorized service facilities, and that the diagnostic information may be used for any purpose. See your SYNC® supplement for more information.

### **Event Data Recording**

Other modules in your vehicle — event data recorders — are capable of collecting and storing data during a crash or near crash event. The recorded information may assist in the investigation of such an event. The modules may record information about both the vehicle and the occupants, potentially including information such as:

- how various systems in your vehicle were operating;
- whether or not the driver and passenger seatbelts were buckled;
- how far (if at all) the driver was depressing the accelerator and/or the brake pedal;
- how fast the vehicle was traveling; and
- where the driver was positioning the steering wheel.

## Introduction

To access this information, special equipment must be directly connected to the recording modules. Ford Motor Company and Ford of Canada do not access event data recorder information without obtaining consent, unless pursuant to court order or where required by law enforcement, other government authorities or other third parties acting with lawful authority. Other parties may seek to access the information independently of Ford Motor Company and Ford of Canada. Please note that once 911 Assist (if equipped) is enabled (set ON), 911 Assist may, through any paired and connected cell phone, disclose to emergency services that the vehicle has been in a crash involving the deployment of an airbag or, in certain vehicles, the activation of the fuel pump shut-off. Certain versions or updates to 911 Assist may also be capable of electronically or verbally disclosing to 911 operators the vehicle location, and/or other details about the vehicle or crash to assist 911 operators to provide the most appropriate emergency services. If you do not want to disclose this information, do not activate the feature. See your *SYNC*® supplement for more information.

### **Important information for P215/45R17 low-profile tires and wheels**

If your vehicle is equipped with P215/45R17 tires, they are low-profile tires. These tires and wheels are designed to give your vehicle a sport appearance. With low-profile tires, you may notice an increase in road noise and faster tire wear, depending on road conditions and driving styles. Due to their design, low-profile tires and wheels are more prone to road damage from potholes, rough or unpaved roads, car wash rails and curb contact than standard tires and wheels. Your vehicle's warranty does not cover these types of damage. Tires should always be kept at the correct inflation pressures and extra caution should be taken when operating on rough roads to avoid impacts that could cause wheel and tire damage.



## Introduction

### Cell phone use

The use of Mobile Communications Equipment has become increasingly important in the conduct of business and personal affairs. However, drivers must not compromise their own or others' safety when using such equipment. Mobile Communications can enhance personal safety and security when appropriately used, particularly in emergency situations. Safety must be paramount when using mobile communications equipment to avoid negating these benefits.

Mobile Communication Equipment includes, but is not limited to cellular phones, pagers, portable email devices, in-vehicle communications systems, telematics devices and portable two-way radios.



**WARNING:** Driving while distracted can result in loss of vehicle control, accident and injury. Ford strongly recommends that drivers use extreme caution when using any device that may take their focus off the road. The driver's primary responsibility is the safe operation of their vehicle. Only use cell phones and other devices not essential to the driving task when it is safe to do so.



















### Export unique (Non–United States/Canada) vehicle specific information

For your particular global region, your vehicle may be equipped with features and options that are different from the features and options that are described in this *Owner's Guide*. A market unique supplement may be supplied that complements this book. By referring to the market unique supplement, if provided, you can properly identify those features, recommendations and specifications that are unique to your vehicle. This *Owner's Guide* is written primarily for the U.S. and Canadian Markets. Features or equipment listed as standard may be different on units built for Export. **Refer to this Owner's Guide for all other required information and warnings.**

## Introduction

These are some of the symbols you may see on your vehicle.

### Vehicle Symbol Glossary

Safety Alert		See Owner's Guide	
Fasten Safety Belt		Airbag - Front	
Airbag - Side		Child Seat Lower Anchor	
Child Seat Tether Anchor		Brake System	
Anti-Lock Brake System		Parking Brake System	
Brake Fluid - Non-Petroleum Based		Parking Aid System	
Stability Control System		Speed Control	
Master Lighting Switch		Hazard Warning Flasher	
Fog Lamps-Front		Fuse Compartment	
Fuel Pump Reset		Windshield Wash/Wipe	
Windshield Defrost/Demist		Rear Window Defrost/Demist	

## Introduction

### Vehicle Symbol Glossary

Power Windows Front/Rear		Power Window Lockout	
Child Safety Door Lock/Unlock		Interior Luggage Compartment Release	
Panic Alarm		Engine Oil	
Engine Coolant		Engine Coolant Temperature	
Do Not Open When Hot		Battery	
Avoid Smoking, Flames, or Sparks		Battery Acid	
Explosive Gas		Fan Warning	
Power Steering Fluid		Maintain Correct Fluid Level	
Service Engine Soon		Engine Air Filter	
Passenger Compartment Air Filter		Jack	
Check Fuel Cap		Low Tire Pressure Warning	

## Instrument Cluster

### WARNING LIGHTS AND CHIMES

#### Standard instrument cluster

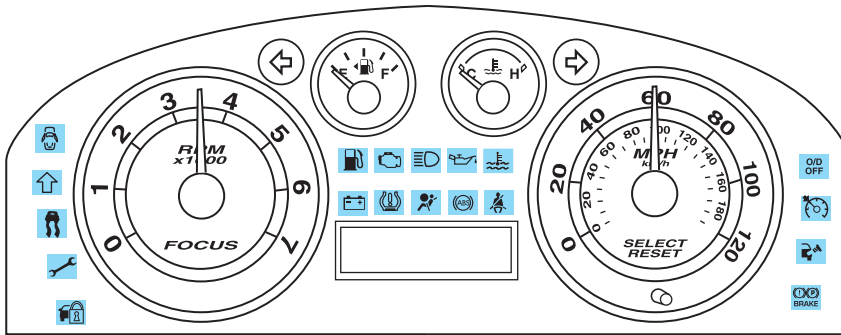

#### Optional instrument cluster

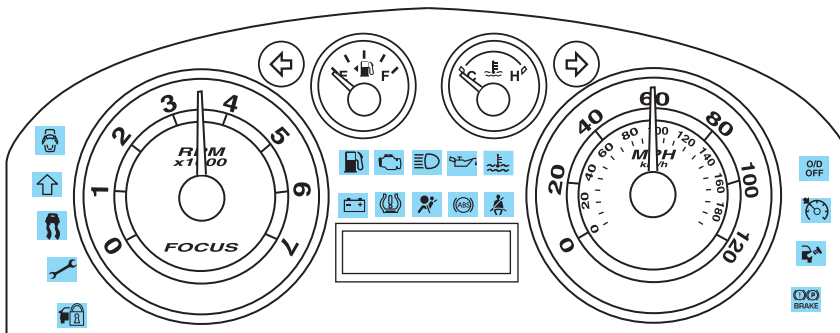

Warning lights and gauges can alert you to a vehicle condition that may become serious enough to cause expensive repairs. A warning light may illuminate when a problem exists with one of your vehicle's functions. Many lights will illuminate when you start your vehicle to make sure the bulb works. If any light remains on after starting the vehicle, refer to the respective system warning light for additional information.

## Instrument Cluster

**Service engine soon:** The *Service engine soon* indicator light

illuminates when the ignition is first turned to the on position to check the bulb and to indicate whether the vehicle is ready for Inspection/Maintenance (I/M) testing. Normally, the “Service engine soon” light will stay on until the engine is cranked, then turn itself off if no malfunctions are present. However, if after 15 seconds the “Service engine soon” light blinks eight times, it means that the vehicle is not ready for I/M testing. See the *Readiness for Inspection/Maintenance (I/M) testing* in the *Maintenance and Specifications* chapter.



Solid illumination after the engine is started indicates the On Board Diagnostics System (OBD-II) has detected a malfunction. Refer to *On board diagnostics (OBD-II)* in the *Maintenance and Specifications* chapter. If the light is blinking, engine misfire is occurring which could damage your catalytic converter. Drive in a moderate fashion (avoid heavy acceleration and deceleration) and have your vehicle serviced immediately by your authorized dealer.



**WARNING:** Under engine misfire conditions, excessive exhaust temperatures could damage the catalytic converter, the fuel system, interior floor coverings or other vehicle components, possibly causing a fire.

**Check fuel cap:** Illuminates when the fuel cap may not be properly installed. Continued driving with this light on may cause the Service engine soon warning light to come on, refer to *Fuel filler cap* in the *Maintenance and Specification* chapter.



**Brake system warning light:** To confirm the brake system warning light is functional, it will momentarily illuminate when the ignition is turned to the on position when the engine is not running, or in a position between on and start, or by applying the parking brake when the ignition is turned to the on position. If the brake system warning light does not illuminate at this time, seek service immediately from your authorized dealer. Illumination



## Instrument Cluster

after releasing the parking brake indicates low brake fluid level and the brake system should be inspected immediately by your authorized dealer.



**WARNING:** Driving a vehicle with the brake system warning light on is dangerous. A significant decrease in braking performance may occur. It will take you longer to stop the vehicle. Have the vehicle checked by your authorized dealer. Driving extended distances with the parking brake engaged can cause brake failure and the risk of personal injury.

### **Anti-lock brake system (if equipped):**

If the ABS light stays illuminated or continues to flash, a malfunction has been detected, have the system serviced immediately by your authorized dealer. Normal braking is still functional unless the brake warning light also is illuminated.

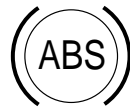

**Airbag readiness:** If this light fails to illuminate when the ignition is turned to on, continues to flash or remains on, have the system

serviced immediately by your authorized dealer. A chime will sound when there is a malfunction in the indicator light.



**Safety belt:** Reminds you to fasten your safety belt. A Belt-Minder® chime will also sound to remind you to fasten your safety belt. Refer to the *Seating and Safety Restraints* chapter to activate/deactivate the Belt-Minder® chime feature.



**Charging system:** Illuminates when the battery is not charging properly. If it stays on while the engine is running, there may be a malfunction with the charging system. Contact your authorized dealer as soon as possible. This indicates a problem with the electrical system or a related component.



**Engine oil pressure:** Illuminates when the oil pressure falls below the normal range, refer to *Engine oil* in the *Maintenance and Specifications* chapter.

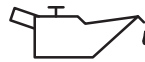

## Instrument Cluster

### Engine coolant temperature:

Illuminates when the engine coolant temperature is high. Stop the vehicle as soon as possible, switch off the engine and let cool. Refer to *Engine coolant* in the *Maintenance and Specifications* chapter.



**WARNING:** Never remove the coolant reservoir cap while the engine is running or hot.

**Anti-theft system:** Flashes when the SecuriLock™ Passive Anti-theft system has been activated.



### Overdrive off (if equipped):

Illuminates when the overdrive function of the transaxle has been turned off, refer to the *Driving* chapter. If the light flashes steadily or does not illuminate, have the transmission serviced soon, or damage may occur.



### Speed control (if equipped):

Illuminates when the speed control is activated. Turns off when the speed control system is deactivated, refer to the *Driver Controls* chapter for more information.



**Upshift (if equipped):** To maximize fuel economy, this light illuminates when the manual transmission should be shifted to the next highest gear. Refer to the *Driving* chapter for more information.



### Low tire pressure warning:

Illuminates when your tire pressure is low. If the light remains on at start up or while driving, the tire pressure should be checked. Refer to *Inflating your tires* in the *Tires, Wheels and Loading* chapter. When the ignition is first turned to on, the light will illuminate for three seconds to ensure the bulb is working. If the light does not turn on or begins to flash, have the system inspected by your authorized dealer. For

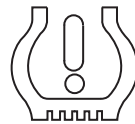

## Instrument Cluster

more information on this system, refer to *Tire pressure monitoring system (TPMS)* in the *Tires, Wheels and Loading* chapter.

**AdvanceTrac®/Traction Control™ system (if equipped):**

Illuminates when the AdvanceTrac®/Traction Control™ is turned off and will flash when active. If the light remains on, have the system serviced immediately, refer to the *Driving* chapter for more information.



**Throttle Control/Transmission:**

Illuminates when a powertrain fault has been detected. Contact your authorized dealer as soon as possible.



**Low fuel:** Illuminates when the fuel level in the fuel tank is at or near empty (refer to *Fuel gauge* in this chapter).



**Door ajar:** Illuminates when the ignition is in the on position and any door is open.



**Turn signal:** Illuminates when the left or right turn signal or the hazard lights are turned on. If the indicators stay on or flash faster, check for a burned out bulb.



**High beams:** Illuminates when the high beam headlamps are turned on.



**Key-in-ignition warning chime:** Sounds when the key is left in the ignition in the off or accessory position and the driver's door is opened.

**Headlamps on warning chime:** Sounds when the headlamps or parking lamps are on, the ignition is off (the key is not in the ignition) and the driver's door is opened.



## Instrument Cluster

### GAUGES

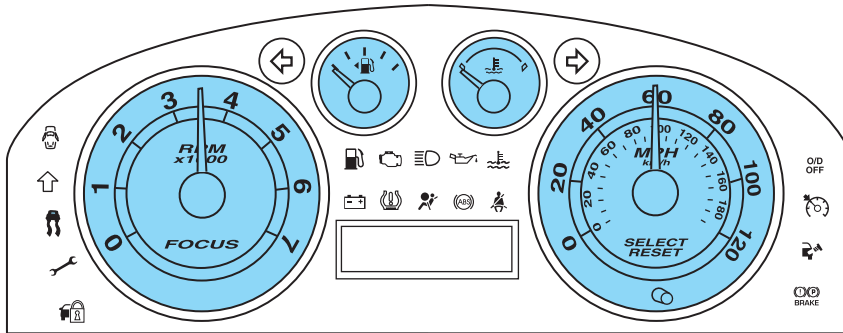

**Speedometer:** Indicates the current vehicle speed.

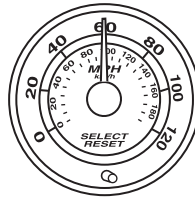

**Engine coolant temperature gauge:** Indicates engine coolant temperature. At normal operating temperature, the needle will be in the normal range. **If it enters the red section, the engine is overheating. Stop the vehicle as soon as safely possible, switch off the engine and let the engine cool.** If it enters the red section and the *Service engine soon* indicator light illuminates, refer to *How fail safe cooling works* in the *Maintenance and Specifications* chapter.

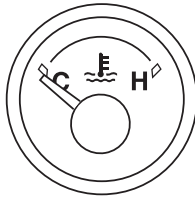

**WARNING:** Never remove the coolant reservoir cap while the engine is running or hot.

## Instrument Cluster

**Odometer:** Registers the total miles (kilometers) of the vehicle.

If equipped with a message center, refer to *Message center* in the *Driver Controls* chapter on how to switch the display from Metric to English.



**Trip odometer:** Registers the miles (kilometers) of individual journeys.

• **Standard instrument cluster:**

Press the SELECT/RESET control once to switch from the odometer to the TRIP A feature. Press the control again to select the TRIP B feature. To reset the trip, press and hold the control again until the trip reading is 0.0 miles.

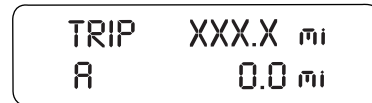

• **Optional instrument cluster:**

Press and release the message center INFO button until TRIP A mode appears in the display. Press the control again to select the TRIP B feature. Press and hold the RESET button to reset.

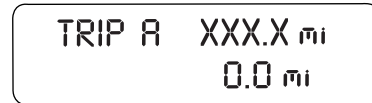

**Tachometer:** Indicates the engine speed in revolutions per minute. Driving with your tachometer pointer continuously at the top of the scale may damage the engine.

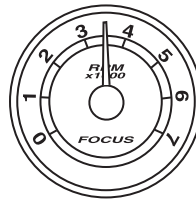

**Fuel gauge:** Indicates approximately how much fuel is left in the fuel tank (when the ignition is in the on position). The fuel gauge may vary slightly when the vehicle is in motion or on a grade.

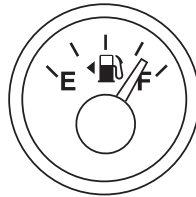

Refer to *Filling the tank* in the *Maintenance and Specifications* chapter for more information.

## Entertainment Systems

### AUDIO SYSTEMS

#### AM/FM/single CD or in-dash CD6/MP3 satellite compatible sound system

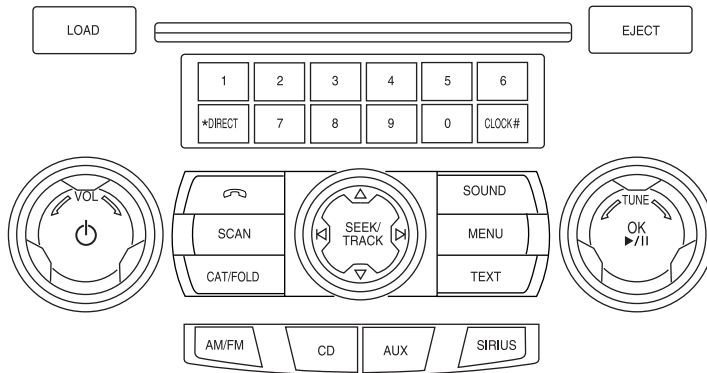

**WARNING:** Driving while distracted can result in loss of vehicle control, accident and injury. Ford strongly recommends that drivers use extreme caution when using any device that may take their focus off the road. The driver's primary responsibility is the safe operation of their vehicle. Only use cell phones and other devices not essential to the driving task when it is safe to do so.

**Accessory delay:** Your vehicle is equipped with accessory delay. With this feature, the radio and other electrical accessories may be used for up to ten minutes after the ignition is turned off or until either front door is opened.

**Note:** Your vehicle is equipped with a unique audio system. If your display shows six small circles in the display, your audio system is a CD6 system. If not, your system is a Single CD system.

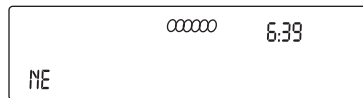

#### **Setting the clock**

To set the time, press CLOCK#. The display will read SET TIME. Use the memory preset numbers (0–9) to enter in the desired time—hours and minutes. The clock will then begin from that time.

## Entertainment Systems

### AM/FM Radio

**⏻ / VOL (Power/Volume):** Press to turn the radio on/off. Turn the knob to increase/decrease volume.

If the volume is set above a certain level and the ignition is turned off, the volume will come back on at a nominal listening level when the ignition switch is turned back on.

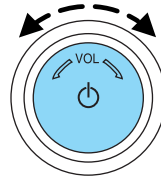

**AM/FM:** Press repeatedly to select AM/FM1/FM2 frequency band.

**TUNE:** Turn the knob to go up/down the frequency band in individual increments.

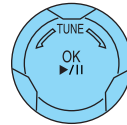

**DIRECT:** Press DIRECT and then select the desired radio frequency (i.e. 93.9) using the memory preset numbers (0–9).

**SEEK/TRACK:** Press ◀ SEEK/TRACK ▶ to access the previous/next strong radio station.



**SCAN:** Press for a brief sampling of all strong radio stations.

**MEMORY PRESETS (0–9):** When tuned to any station, press and hold a preset button until sound returns and PRESET # SAVED appears in the display. You can save up to 30 stations, 10 in AM, 10 in FM1 and FM2.

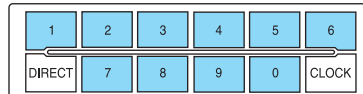

*Saving presets automatically*– Autoset allows you to set the strongest local radio stations without losing your original manually set preset stations for AM/FM1/FM2.

*To activate the autoset feature:* Press MENU repeatedly until AUTO PRESET ON/OFF appears in the display. Use ◀ SEEK/TRACK ▶ to toggle AUTO PRESET to ON, and either wait five seconds for the search to initiate or press OK to immediately initiate the search. If you press

## Entertainment Systems

another control within those five seconds, the search will not initiate. The 10 strongest stations will be filled and the station stored in preset 1 will begin playing.

If there are fewer than 10 strong stations, the system will store the last one in the remaining presets.

### **RDS Radio**

Available only in FM mode. This feature allows you to search RDS-equipped stations for a certain category of music format: CLASSIC, COUNTRY, JAZZ/RB, ROCK, etc.

*To activate:* Press MENU repeatedly until RDS (ON/OFF) appears in the display. Use ◀ SEEK/TRACK ▶ to toggle RDS ON/OFF. When RDS is OFF, you will not be able to search for RDS equipped stations or view the station name or type.

**CAT/FOLD(Category/Folder):** This feature allows you to select from various music categories.

*To change RDS categories:* Press MENU repeatedly until RDS ON/OFF appears in the display. Use ▲ / ▼ to toggle RDS to ON. Press CAT. PRESS UP OR DOWN TO CHANGE RDS CATEGORY will appear in the display. Press ▲ / ▼ to scroll through all possible categories. When the desired category appears in the display, press ◀ SEEK/TRACK ▶ to find the next station playing that selection or press SCAN for a brief sampling of all stations playing that category of music.

### **CD/MP3 Player**

**CD:** Press to enter CD/MP3 mode. If a disc is already loaded into the system, CD/MP3 play will begin where it ended last. If no CD is loaded, NO DISC will appear in the display.

#### **LOAD:**

**For a single CD system–** This control is not operational. To load a CD, simply insert the disc, label side up, into the CD slot.

**For a CD6 system–** Press LOAD. When the display reads SELECT SLOT, choose the desired slot number using memory presets 1–6. When the display reads LOAD CD#, load the desired disc, label side up. If you do not choose a slot within five seconds, the system will choose for you. Once loaded, the first track will begin to play.

*To auto load up to six discs–* Press and hold LOAD until the display reads AUTOLOAD#. Load the desired disc, label side up. The system will prompt you to load discs for the remaining available slots. Insert the

## Entertainment Systems

discs, one at a time, label side up, when prompted. Once loaded, the disc in preset #1 will begin to play.

Press the number preset buttons (1–6) to choose the disc you want to play.

### **EJECT:**

**For a single CD system–** press EJECT to eject the CD.

**For a CD6 system–** press EJECT and select the desired CD slot by pressing the corresponding memory preset #. The display will read EJECTING #. When the system has ejected the CD, the display will read REMOVE CD #. Remove the CD. If you do not remove the CD, the system will reload the disc.

*To auto eject all loaded discs–* Press and hold EJECT. The system will eject all discs and prompt you when to remove them.

**▶ / || Play/Pause:** Press to play/pause a track when playing a CD.

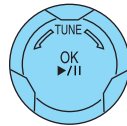

**SEEK/TRACK:** Press ◀ SEEK/TRACK ▶ to access the previous/next track.



### **CAT (Category) / FOLD (Folder):**

*In MP3 mode only–* Press CAT/FOLD and then press ◀ SEEK/TRACK ▶ to access the previous/next folder.

**SCAN:** Press for a brief sampling of all tracks on the current disc or MP3 folder.

### **DIRECT:**

*In CD mode–* Press DIRECT. The display will read DIRECT TRACK MODE SELECT TRACK. Enter the desired track number using the memory preset buttons (0–9). The system will then begin playing that track.

*In MP3 folder mode–* Press DIRECT and the memory preset buttons (0–9) of the desired folder. The system will advance to that specific folder.

## Entertainment Systems

### **TEXT:**

*In MP3 mode only*– Press TEXT repeatedly to view Album (AL), Folder (FL), Song (SO) and Artist (AR) in the display, if available.

*In TEXT MODE:* Sometimes the display requires additional text to be displayed. When the < / > indicator is active, press TEXT and then press ◀ SEEK/TRACK ▶ to view the additional display text.

**COMPRESSION:** Press MENU repeatedly until COMPRESSION ON/OFF appears in the display. Use ◀ SEEK/TRACK ▶ to toggle between ON/OFF. When COMPRESSION is ON, the system will bring the soft and loud CD passages together for a more consistent listening level.

**SHUFFLE:** Press MENU repeatedly until SHUFFLE ON/OFF appears in the display. Use ◀ SEEK/TRACK ▶ to toggle between ON/OFF. If you wish to engage shuffle mode right away, press ◀ SEEK/TRACK ▶ to begin random play. Otherwise, random play will begin when the current track is finished playing. The system will only shuffle the currently playing disc.

### **Satellite Radio (if equipped)**

*Satellite radio is available only with a valid SIRIUS radio subscription. Check with your authorized dealer for availability.*

**SIRIUS:** Press repeatedly to access satellite radio mode, if equipped. Press repeatedly to cycle through SAT1, SAT2 and SAT3 modes.

**TUNE/OK:** Turn the knob to go to the next / previous available SIRIUS satellite station.

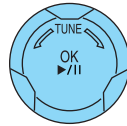

**DIRECT:** Press DIRECT then enter the desired channel (i.e. 002) using the memory preset buttons (0–9). If you only enter one digit, press OK and the system will go to that satellite channel. If you enter three digits, the system will automatically go to that channel, if available. You may cancel your entry by pressing DIRECT. If an invalid station number is entered, INVALID CHANNEL will appear in the display and the system will continue playing the current station.

## Entertainment Systems

**SEEK/TRACK:** Press ◀

SEEK/TRACK ▶ to seek to the previous/next channel. If a specific category is selected, (Jazz, Rock, News, etc.), press ◀

SEEK/TRACK ▶ to seek to the previous/next channel in the selected category. Press and hold ◀  
SEEK/TRACK ▶ to fast seek through the previous/next channels.



**SCAN:** Press SCAN for a brief sampling of all available SIRIUS satellite channels. If a specific category is selected, (Jazz, Rock, News, etc.) press SCAN for a brief sampling of all available SIRIUS satellite channels within the selected category.

**MEMORY PRESETS (0-9):** There are 30 available presets, 10 each for SAT1, SAT2 and SAT3. To save satellite channels in your memory presets, tune to the desired channel then press and hold a memory preset number (0-9) until sound returns.

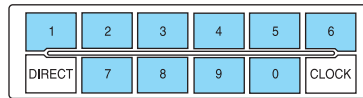

**TEXT:** Press and release to display the artist and song title. While in TEXT MODE, press again to scroll through the Artist (AR), Song (SO), Channel (CH) and Category (CA).

*In TEXT MODE:* Sometimes the display requires additional text to be displayed. When the < / > indicator is active, press TEXT and then press ◀ SEEK/TRACK ▶ to view the additional display text.

**CAT (Category) / FOLD (Folder):** Press to toggle between turning the most recently selected satellite radio category on or off. The category icon (CAT) will illuminate in the display when a specific category is selected (the icon will not illuminate during CATEGORY ALL). If no category has ever been selected, NO CATEGORY SELECTED will display.

**Note:** Separate categories can be set for SAT1, SAT2 or SAT3. Refer to *Satellite radio menu* for further information on selecting a satellite radio category.

**SATELLITE RADIO MENU:** Press MENU when satellite radio mode is active to access. Press OK to enter into the satellite radio menu.

Press ▲ / ▼ to cycle through the following options:

- **CATEGORY MENU-** Press OK to enter category mode.  
Press ▲ / ▼ to scroll through the list of available SIRIUS channel Categories (Pop, Rock, News, etc.) Press OK when the desired



## Entertainment Systems

category appears in the display. After a category is selected, press ▲ / ▼ to search for that specific category of channels only (i.e. ROCK). You may also select CATEGORY ALL to seek all available SIRIUS categories and channels. Press OK to close and return to the main menu.

- **SONG SEEK MENU-** Press OK to enter song seek menu. Press ▲ / ▼ to scroll through the following options:
  - a. SAVE THIS SONG:** Press OK to save the currently playing song's title in the system's memory. (If you try to save something other than a song, CANT SAVE will appear in the display.) When the chosen song is playing on any satellite radio channel, the system will alert you with an audible prompt. Press OK while SONG ALERT is in the display and the system will take you to the channel playing the desired song. You can save up to 20 song titles. If you attempt to save more than 20 titles, the display will read REPLACE SONG? Press OK to access the saved titles and press ▲ / ▼ to cycle through the saved titles. When the song title appears in the display that you would like to replace, press OK. SONG REPLACED will appear in the display.
  - b. DELETE A SONG:** Press OK to delete a song from the system's memory. Press ▲ / ▼ to cycle through the saved songs. When the song appears in the display that you would like to delete, press OK. The song will appear in the display for confirmation. Press OK again and the display will read SONG DELETED. If you do not want to delete the currently listed song, press ▲ / ▼ to select either RETURN or CANCEL.  
**Note:** If there are no songs presently saved, the display will read NO SONGS.
  - c. DELETE ALL SONGS:** Press OK to delete all song's from the system's memory. The display will read ARE YOU SURE ? Press OK to confirm deletion of all saved songs and the display will read ALL DELETED.  
**Note:** If there are no songs presently saved, the display will read NO SONGS.
  - d. DISABLE ALERTS/ENABLE ALERTS:** Press OK to enable/disable the satellite alert status which alerts you when your selected songs are playing on a satellite radio channel. (The system default is disabled.) SONG ALERTS ENABLED/DISABLED will appear in the display. The menu listing will display the opposite state. For example, if you have chosen to enable the song alerts, the menu listing will read DISABLE as the alerts are currently on, so your other option is to turn them off.

## Entertainment Systems

- **CHANNEL LOCKOUT MENU-** Press OK to enter the Channel Lockout menu. Press the ▲ / ▼ to scroll through the following options:
  - a. LOCK/UNLOCK THIS CHANNEL:** Press OK when LOCK/UNLOCK THIS CHANNEL is displayed and the display will read ENTER PIN. Enter your four-digit PIN number (initial PIN is 1234) and the system will lock/unlock the channel and CHANNEL LOCKED or UNLOCKED will be displayed.

Note: you must be tuned to the specific channel you want to lock/unlock when using this feature.
  - b. CHANGE PIN:** Press OK when CHANGE PIN is displayed. The display will read ENTER OLD PIN. Enter your current (old) PIN number and when the system accepts your entry it will display ENTER NEW PIN. Enter your new four-digit PIN and the system will save the new PIN and PIN SAVED will display.
  - c. UNLOCK ALL CHANNELS:** Press OK when UNLOCK ALL CHANNELS is displayed and the display will read ENTER PIN. Enter your four-digit PIN and the system will unlock all channels and the display will read CHANNEL UNLOCKED.
  - d. RESET PIN:** Press OK when RESET PIN is displayed. The display will read ARE YOU SURE. Press OK again to automatically reset the PIN number to its initial password setting (1234). PIN RESET TO DEFAULT PIN will be displayed.
  - e. RETURN:** Press OK when RETURN is displayed and the system will exit back to the satellite radio menu.

### Sound Adjustments

Press SOUND repeatedly to cycle through the following features:

**BASS:** Press ◀ SEEK/TRACK ▶ to adjust the level of bass.

**TREBLE:** Press ◀ SEEK/TRACK ▶ to adjust the level of treble.

**BALANCE:** Press ◀ SEEK/TRACK ▶ to adjust the audio between the left (L) and right (R) speakers.

**FADE:** Press ◀ SEEK/TRACK ▶ to adjust the audio between the back (B) and front (F) speakers.

**SPEED COMPENSATED VOLUME:** With this feature on, radio volume automatically gets louder with increasing vehicle speed to compensate for road and wind noise.

The default setting is *off*.

## Entertainment Systems

Use ◀ SEEK/TRACK ▶ to adjust between SPEED OFF and levels 1–7: Increasing the level from 1 (lowest setting) to 7 (highest setting) allows the radio volume to automatically change slightly with vehicle speed to compensate for road and wind noise.

Recommended level is 1–3; SPEED OFF turns the feature off and level 7 is the maximum setting.

**ALL SEATS (Occupancy mode, if equipped):** Press SOUND repeatedly to reach the Occupancy mode setting. Press ◀ SEEK/TRACK ▶ to select and optimize sound for ALL SEATS, DRIVERS SEAT or REAR SEATS.

### Extra Features

**AUX:** Press repeatedly to cycle through LINE IN (auxiliary audio mode), and SYNC (if equipped).

For location and further information on auxiliary audio mode, refer to *Auxiliary input jack* later in this chapter.

If your vehicle is equipped with SYNC, refer to the *SYNC* information included with your vehicle for further information.

**OK:** Your vehicle may be equipped with special phone and media features which will require you to confirm commands by pressing OK. Refer to the *SYNC* information included with your vehicle for further information.

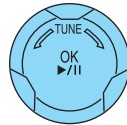

**☎ (Phone):** If your vehicle is equipped with SYNC, press to access SYNC PHONE features. Refer to the *SYNC* information included with your vehicle for further information. If your vehicle is not equipped with SYNC, the display will read NO PHONE.

### Auxiliary input jack (Line in)

 **WARNING:** Driving while distracted can result in loss of vehicle control, accident and injury. Ford strongly recommends that drivers use extreme caution when using any device that may take their focus off the road. The driver's primary responsibility is the safe operation of their vehicle. Only use cell phones and other devices not essential to the driving task when it is safe to do so.

## Entertainment Systems

The Auxiliary Input Jack provides a way to connect your portable music player to the in-vehicle audio system. This allows the audio from a portable music player to be played through the vehicle speakers with high fidelity. To achieve optimal performance, please observe the following instructions when attaching your portable music device to the audio system.

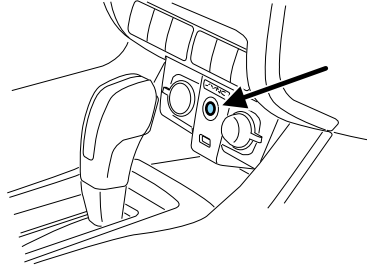

If your vehicle is equipped with a navigation system, refer to *Auxiliary input jack* section in the *Audio features* chapter of your *Navigation system* supplement.

### Required equipment:

1. Any portable music player designed to be used with headphones
2. An audio extension cable with stereo male 1/8 in. (3.5 mm) connectors at each end

### To play your portable music player using the auxiliary input jack:

1. Begin with the vehicle parked and the radio turned off.
2. Ensure that the battery in your portable music player is new or fully charged and that the device is turned off.
3. Attach one end of the audio extension cable to the headphone output of your player and the other end of the audio extension cable to the AIJ in your vehicle.
4. Turn the radio on, using either a tuned FM station or a CD loaded into the system. Adjust the volume to a comfortable listening level.
5. Turn the portable music player on and adjust the volume to 1/2 the volume.
6. Press AUX on the vehicle radio repeatedly until LINE, LINE IN or SYNC LINE IN appears in the display. You should hear audio from your portable music player although it may be low.
7. Adjust the sound on your portable music player until it reaches the level of the FM station or CD by switching back and forth between the AUX and FM or CD controls.

### Troubleshooting:

1. Do not connect the audio input jack to a line level output. Line level outputs are intended for connection to a home stereo and are not

## Entertainment Systems

compatible with the AIJ. The AIJ will only work correctly with devices that have a headphone output with a volume control.

2. Do not set the portable music player's volume level higher than is necessary to match the volume of the CD or FM radio in your audio system as this will cause distortion and will reduce sound quality. Many portable music players have different output levels, so not all players should be set at the same levels. Some players will sound best at full volume and others will need to be set at a lower volume.

3. If the music sounds distorted at lower listening levels, turn the portable music player volume down. If the problems persists, replace or recharge the batteries in the portable music player.

4. The portable music player must be controlled in the same manner when it is used with headphones as the AIJ does not provide control (play, pause, etc.) over the attached portable music player.

5. For safety reasons, connecting or adjusting the settings on your portable music player should not be attempted while the vehicle is moving. Also, the portable music player should be stored in a secure location, such as the center console or the glove box, when the vehicle is in motion. The audio extension cable must be long enough to allow the portable music player to be safely stored while the vehicle is in motion.

### USB port (if equipped)



**WARNING:** Driving while distracted can result in loss of vehicle control, accident and injury. Ford strongly recommends that drivers use extreme caution when using any device that may take their focus off the road. The driver's primary responsibility is the safe operation of their vehicle. Only use cell phones and other devices not essential to the driving task when it is safe to do so.

Your vehicle may be equipped with a USB port inside your center console. This feature allows you to plug in media playing devices, memory sticks, and also to charge devices if they support this feature. For further information on this feature, refer to *Accessing and using your USB port* in the *SYNC* supplement or *Navigation system* supplement.

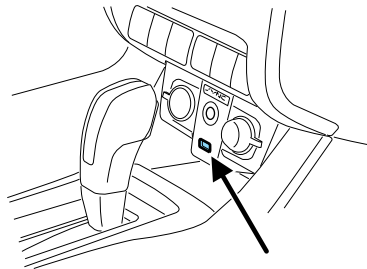

## Entertainment Systems

### GENERAL AUDIO INFORMATION

#### Radio frequencies:

AM and FM frequencies are established by the Federal Communications Commission (FCC) and the Canadian Radio and Telecommunications Commission (CRTC). Those frequencies are:

AM: 530, 540–1700, 1710 kHz

FM: 87.7, 87.9–107.7, 107.9 MHz

#### Radio reception factors:

There are three factors that can affect radio reception:

- Distance/strength: The further you travel from an FM station, the weaker the signal and the weaker the reception.
- Terrain: Hills, mountains, tall buildings, power lines, electric fences, traffic lights and thunderstorms can interfere with your reception.
- Station overload: When you pass a broadcast tower, a stronger signal may overtake a weaker one and play while the weak station frequency is displayed.

#### CD/CD player care

Do:

- Handle discs by their edges only. (Never touch the playing surface).
- Inspect discs before playing.
- Clean only with an approved CD cleaner.
- Wipe discs from the center out.



Don't:

- Expose discs to direct sunlight or heat sources for extended periods of time.
- Clean using a circular motion.

## Entertainment Systems

CD units are designed to play commercially pressed 4.75 in (12 cm) audio compact discs only. Due to technical incompatibility, certain recordable and re-recordable compact discs may not function correctly when used in Ford CD players.

Do not use any irregular shaped CDs or discs with a scratch protection film attached.



CDs with homemade paper (adhesive) labels should not be inserted into the CD player as the label may peel and cause the CD to become jammed. It is recommended that homemade CDs be identified with permanent felt tip marker rather than adhesive labels. Ballpoint pens may damage CDs. Please contact your authorized dealer for further information.

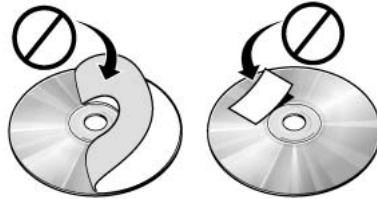

### Audio system warranty and service

Refer to the *Warranty Guide/Customer Information Guide* for audio system warranty information. If service is necessary, see your dealer or qualified technician.

### MP3 track and folder structure

Your MP3 system recognizes MP3 individual tracks and folder structure as follows:

- There are two different modes for MP3 disc playback: MP3 track mode (system default) and MP3 folder mode. For more information on track and folder mode, refer to *Sample MP3 structure* in the following section.
- MP3 track mode ignores any folder structure on the MP3 disc. The player numbers each MP3 track on the disc (noted by the .mp3 file extension) from T001 to a maximum of T255.

**Note:** The maximum number of playable MP3 files may be less depending on the structure of the CD and exact model of radio present.

## Entertainment Systems

- MP3 folder mode represents a folder structure consisting of one level of folders. The CD player numbers all MP3 tracks on the disc (noted by the .mp3 file extension) and all folders containing MP3 files, from F001 (folder) T001 (track) to F253 T255.
- Creating discs with only one level of folders will help with navigation through the disc files.

### Sample MP3 structure

If you are burning your own MP3 discs, it is important to understand how the system will read the structures you create. While various files may be present, (files with extensions other than mp3), only files with the .mp3 extension will be played. Other files will be ignored by the system. This enables you to use the same MP3 disc for a variety of tasks on your work computer, home computer and your in vehicle system.

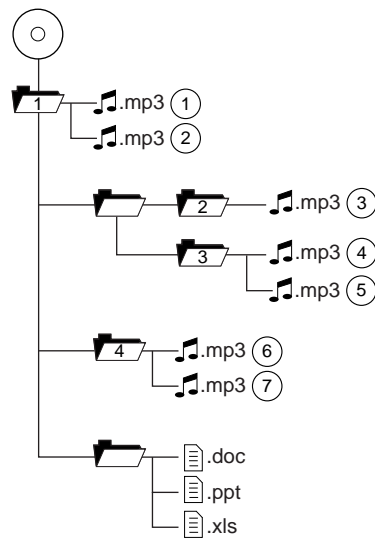

In track mode, the system will display and play the structure as if it were only one level deep (all .mp3 files will be played, regardless of being in a specific folder). In folder mode, the system will only play the .mp3 files in the current folder.

### Satellite radio information (if equipped)

**Satellite radio channels:** SIRIUS broadcasts a variety of music, news, sports, weather, traffic and entertainment satellite radio channels. For more information and a complete list of SIRIUS satellite radio channels, visit [www.sirius.com](http://www.sirius.com) in the United States, [www.sirius-canada.ca](http://www.sirius-canada.ca) in Canada, or call SIRIUS at 1-888-539-7474.



## Entertainment Systems

**Satellite radio reception factors:** To receive the satellite signal, your vehicle has been equipped with a satellite radio antenna located on the roof of your vehicle. The vehicle roof provides the best location for an unobstructed, open view of the sky, a requirement of a satellite radio system. Like AM/FM, there are several factors that can affect satellite radio reception performance:

- **Antenna obstructions:** For optimal reception performance, keep the antenna clear of snow and ice build-up and keep luggage and other material as far away from the antenna as possible.
- **Terrain:** Hills, mountains, tall buildings, bridges, tunnels, freeway overpasses, parking garages, dense tree foliage and thunderstorms can interfere with your reception.
- **Station overload:** When you pass a ground based broadcast repeating tower, a stronger signal may overtake a weaker one and result in an audio mute.

Unlike AM/FM audible static, you will hear an audio mute when there is a satellite radio signal interference. Your radio display may display NO SIGNAL to indicate the interference.

**SIRIUS satellite radio service:** SIRIUS Satellite Radio is a subscription based satellite radio service that broadcasts music, sports, news and entertainment programming. A service fee is required in order to receive SIRIUS service. Vehicles that are equipped with a factory installed SIRIUS Satellite Radio system include:

- Hardware and limited subscription term, which begins on the date of sale or lease of the vehicle.
- Use of online media player providing access to all SIRIUS music channels over the internet using any computer connected to the internet (U.S. customers only)

For information on extended subscription terms, contact SIRIUS at 1-888-539-7474.

**Note:** SIRIUS reserves the unrestricted right to change, rearrange, add or delete programming including canceling, moving or adding particular channels, and its prices, at any time, with or without notice to you. Ford Motor Company shall not be responsible for any such programming changes.

**Satellite Radio Electronic Serial Number (ESN):** This 12-digit Satellite Serial Number is needed to activate, modify or track your satellite radio account. You will need this number when communicating with SIRIUS. While in Satellite Radio mode, you can view this number on the radio display by pressing the SIRIUS and Preset 1 buttons at the same time.

## Entertainment Systems

Radio Display	Condition	Action Required
ACQUIRING	Radio requires more than two seconds to produce audio for the selected channel.	No action required. This message should disappear shortly.
SAT FAULT	Internal module or system failure present.	If this message does not clear within a short period of time, or with an ignition key cycle, your receiver may have a fault. See your authorized dealer for service.
INVALID CHNL	Channel no longer available.	This previously available channel is no longer available. Tune to another channel. If the channel was one of your presets, you may choose another channel for that preset button.
UNSUBSCRIBED	Subscription not available for this channel.	Contact SIRIUS at 1-888-539-7474 to subscribe to the channel or tune to another channel.
NO TEXT	Artist information not available.	Artist information not available at this time on this channel. The system is working properly.
NO TEXT	Song title information not available.	Song title information not available at this time on this channel. The system is working properly.
NO TEXT	Category information not available.	Category information not available at this time on this channel. The system is working properly.

## Entertainment Systems

Radio Display	Condition	Action Required
NO SIGNAL	Loss of signal from the SIRIUS satellite or SIRIUS tower to the vehicle antenna.	You are in a location that is blocking the SIRIUS signal (i.e., tunnel, under an overpass, dense foliage, etc). The system is working properly. When you move into an open area, the signal should return.
UPDATING	Update of channel programming in progress.	No action required. The process may take up to three minutes.
CALL SIRIUS 1-888-539-7474	Satellite service has been deactivated by SIRIUS Satellite Radio.	Call SIRIUS at 1-888-539-7474 to re-activate or resolve subscription issues.

### **SYNC (IF EQUIPPED)**

Your vehicle may be equipped with SYNC, a hands-free communications and entertainment system with special phone and media features. For more information, please refer to the *SYNC* supplement.

## Climate Controls

### MANUAL HEATING AND AIR CONDITIONING SYSTEM

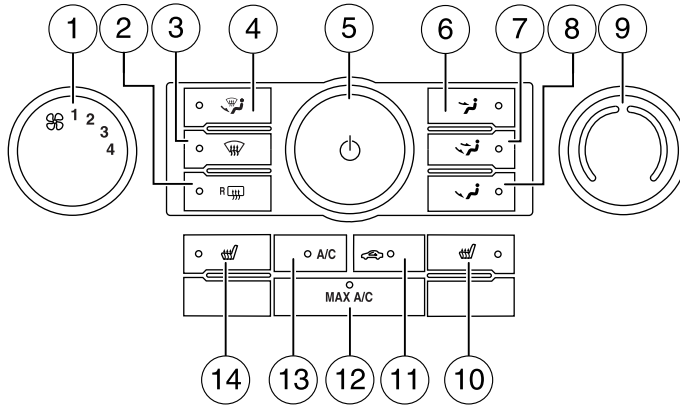





- 1. Fan speed adjustment:** Controls the volume of air circulated in the vehicle.
- 2. Rear defroster:** Press to activate/deactivate the rear window defroster. Refer to *Rear window defroster* later in this chapter for more information.
- 3. Defrost:** Distributes outside air through the windshield defroster vents and demister vents. Can be used to clear the windshield of fog and thin ice. The system will automatically provide outside air to reduce window fogging. Press this button again to return to the previous air flow selection.
- 4. :** Distributes air through the windshield defroster vents, demister vents, floor vents and rear seat floor vents. The system will automatically provide outside air to reduce window fogging.
- 5. Power:** Press to activate/deactivate the climate control system. When the system is off, outside air is prevented from entering the vehicle.
- 6. :** Distributes air through the instrument panel vents.
- 7. :** Distributes air through the instrument panel vents, floor vents, rear seat floor vents and demister vents.
- 8. :** Distributes air through the floor vents, rear seat floor vents and demister vents.



## Climate Controls

9. **Temperature control:** Controls the temperature of the airflow in the vehicle.

10.  **Passenger heated seat control (if equipped):** Press to activate/deactivate the passenger heated seat. See *Heated seats* in the *Seating and Safety Restraints* chapter.



11.  **Recirculated air:** Press to activate/deactivate air recirculation in the vehicle. Recirculated air may reduce the amount of time needed to cool down the interior of the vehicle and may also help reduce undesired odors from reaching the interior of the vehicle. Recirculated air engages automatically when MAX A/C is selected or can be engaged manually in any airflow mode except  (defrost). When the ignition switch is turned off and back on, the climate system will return to the recirculated air mode only if the A/C button LED is illuminated and the air distribution selection is either  (panel) or  (panel/floor).

12. **MAX A/C:** Distributes recirculated air through the instrument panel vents to cool the vehicle. This re-cooling of the interior air is more economical and efficient. Recirculated air may also help reduce undesirable odors from entering the vehicle. Press the MAX A/C button again for normal A/C operation.

13. **A/C:** Press to activate/deactivate air conditioning. Use with recirculated air to improve cooling performance and efficiency. A/C engages automatically in MAX A/C,  (defrost) and  (floor/defrost).

14.  **Driver heated seat control (if equipped):** Press to activate/deactivate the driver heated seat. See *Heated seats* in the *Seating and Safety Restraints* chapter.

### Operating tips

- To reduce fog build up on the windshield during humid weather, select  (defrost) or  (floor/defrost).
- To reduce humidity build up inside the vehicle, do not drive with the system off or with  (recirculated air) engaged and A/C off.
- Do not put objects under the front seats that will interfere with the airflow to the back seats.
- Remove any snow, ice or leaves from the air intake area at the base of the windshield.
- To improve the time to reach comfort in hot weather, drive with the windows slightly open for 2-3 minutes after start up or until the vehicle has been “aired out.”

## Climate Controls

During extreme high ambient temperatures when idling stationary for extended periods of time in gear, it is recommended to run the A/C in the MAX A/C position, reduce blower fan speed from the highest setting and put the vehicle's transmission into the PARK gear position (automatic transmission only) to continue to receive cool air from your A/C system.

### **For maximum cooling performance in MAX A/C mode:**

1. Select MAX A/C.
2. Select the coolest temperature setting.
3. Set the fan to the highest speed initially. As the interior starts to cool down, adjust the fan speed to maintain comfort.

### **To aid in side window defogging/demisting in cold weather:**

1. Select .
2. Select A/C.
3. Adjust the temperature control to maintain comfort.
4. Set the fan speed to the highest setting.
5. Direct the outer instrument panel vents towards the side windows.

To increase airflow to the outer instrument panel vents, close the vents located in the middle of the instrument panel.

### **REAR WINDOW DEFROSTER**

The rear defroster control is located on the climate control panel and works to clear the rear window of fog and thin ice.

The engine must be running to operate the rear window defroster.

Press  to turn the rear window defroster on. An indicator light on the button will illuminate when active. The rear window defroster turns off automatically after a predetermined amount of time, if a low battery condition is detected or when the ignition is turned off or to the accessory position. To manually turn off the rear window defroster at any time, press the control again.

If your vehicle is equipped with both rear defroster and heated mirrors, the same button will activate both. Refer to *Heated outside mirrors* in the *Driver Controls* chapter.

**Do not use razor blades or other sharp objects to clean the inside of the rear window or to remove decals from the inside or the rear window. This may cause damage to the heated grid lines and will not be covered by your warranty.**

## Lights

### HEADLAMP CONTROL ☀

○ Turns the lamps off.

P☞ Turns on the parking lamps, instrument panel lamps, license plate lamps and tail lamps.

☞☞ Turns the low beam headlamps on.

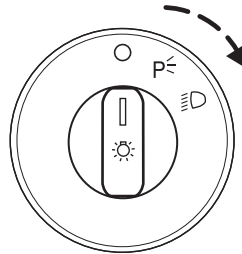

### Fog lamp control (if equipped) ☞☞

The fog lamps can be turned on when the headlamp control is in the ☞☞ or P☞ position and the high beams are not turned on.

Pull headlamp control towards you to turn fog lamps on. The fog lamp indicator light ☞☞ on the headlamp control will illuminate.

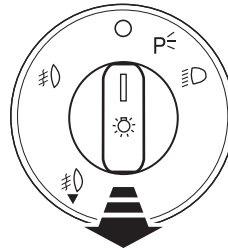

### High beams ☞☞

Push the lever toward the instrument panel to activate. Pull the lever towards you to deactivate.

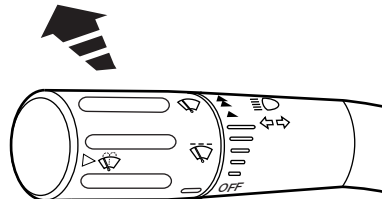

## Lights

### Flash to pass

Pull toward you slightly to activate and release to deactivate.

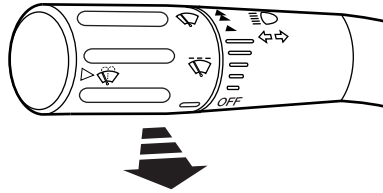

### Daytime running lamps (DRL) (if equipped)

Turns the headlamps on with a reduced output.

To activate:

- the ignition must be in the on position and
- the headlamp control is in the off or parking lamp position.



**WARNING:** Always remember to turn on your headlamps at dusk or during inclement weather. The Daytime Running Lamp (DRL) system does not activate the tail lamps and generally may not provide adequate lighting during these conditions. Failure to activate your headlamps under these conditions may result in a collision.

### PANEL DIMMER CONTROL

Use to adjust the brightness of the instrument panel and all applicable switches in the vehicle during headlamp and parking lamp operation.

Move the control to the full upright position, past detent, to turn on the interior lamps.

**Note:** If the battery is disconnected, discharged, or a new battery is installed, the dimmer switch requires re-calibration. Rotate the dimmer switch from the full dim position to the full dome/on position to reset. This will ensure that your displays are visible under all lighting conditions.

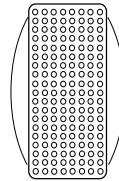



### AIMING THE HEADLAMPS

The headlamps on your vehicle are properly aimed at the assembly plant. If your vehicle has been in an accident, the alignment of your headlamps should be checked by your authorized dealer.

#### Vertical aim adjustment

1. Park the vehicle directly in front of a wall or screen on a level surface, approximately 25 feet (7.6 meters) away.

- (1) 8 feet (2.4 meters)
- (2) Center height of lamp to ground
- (3) 25 feet (7.6 meters)
- (4) Horizontal reference line

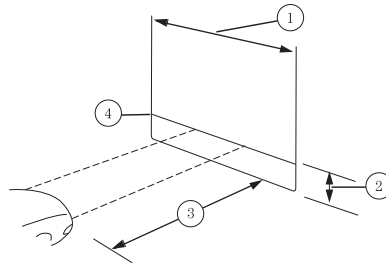

2. Measure the height from the center of your headlamp to the ground and mark an 8 foot (2.4 meter) horizontal reference line on the vertical wall or screen at this height (a piece of masking tape works well).

3. Turn on the low beam headlamps to illuminate the wall or screen and open the hood.

4. On the wall or screen you will observe an area of high intensity light. The top of the high intensity area should touch the horizontal reference line. If not, the beam will need to be adjusted.



## Lights

5. Locate the vertical adjuster on each headlamp, then use a 7 mm Allen wrench or a Phillips screwdriver to adjust the headlamp up or down.

6. HORIZONTAL AIM IS NOT REQUIRED FOR THIS VEHICLE AND IS NON-ADJUSTABLE.

7. Close the hood and turn off the lamps.

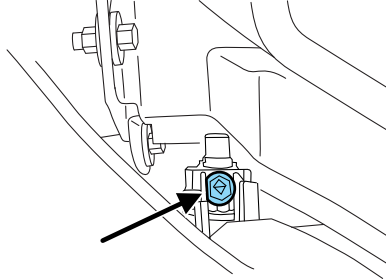

### TURN SIGNAL CONTROL ⇄

- Push down to activate the left turn signal.
- Push up to activate the right turn signal.

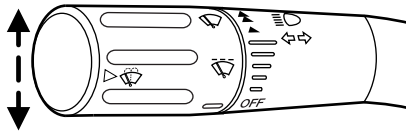

## INTERIOR LAMPS

### Map lamps

To turn on the map lamps, press the outer edge of the clear lens. The map lamp lights when:

- any door is opened.
- the remote entry controls are pressed and the ignition is off.

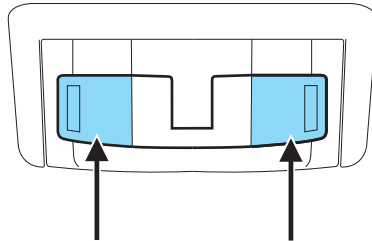

### Ambient lighting (if equipped)

Illuminates four footwells and three cupholders with a choice of seven colors. The ambient lighting control switch is located on the instrument panel. To activate, press and release the control switch to cycle through the seven color choices plus the off state.

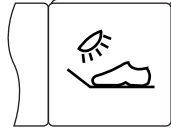

The lights come on whenever the ignition is in either the on or accessory position.

**Note:** The ambient lights will stay on until after the ignition is placed in the off position and either of the front doors are opened or the accessory delay timer expires.

### BULB REPLACEMENT

#### Lamp assembly condensation

Exterior lamps are vented to accommodate normal changes in pressure. Condensation can be a natural by-product of this design. When moist air enters the lamp assembly through the vents, there is a possibility that condensation can occur when the temperature is cold. When normal condensation occurs, a thin film of mist can form on the interior of the lens. The thin mist eventually clears and exits through the vents during normal operation. Clearing time may take as long as 48 hours under dry weather conditions.

Examples of acceptable condensation are:

- Presence of thin mist (no streaks, drip marks or droplets)
- Fine mist covers less than 50% of the lens

Examples of unacceptable moisture (usually caused by a lamp water leak) are:

- Water puddle inside the lamp
- Large water droplets, drip marks or streaks present on the interior of the lens

Take your vehicle to dealer for service if any of the above conditions of unacceptable moisture are present.

## Lights

### Using the right bulbs

Replacement bulbs are specified in the chart below. Headlamp bulbs must be marked with an authorized "D.O.T." for North America to ensure lamp performance, light brightness and pattern and safe visibility. The correct bulbs will not damage the lamp assembly or void the lamp assembly warranty and will provide quality bulb burn time.

Function	Trade number
Headlamps	H13
Park and turn lamp (front)	3457 NAK or 3457AK
Side marker lamp (front)	168
Fog lamps (if equipped)	H11 LL
Stop/turn and tail lamps	3057K
Backup lamp	921
License plate lamp	C5W L
* High-mount brake lamp	LED
* To replace these lamps - see your authorized dealer.	
To replace all instrument panel lights - see your authorized dealer	

### Replacing interior bulbs

Check the operation of all bulbs frequently.

### Replacing exterior bulbs

Check the operation of all the bulbs frequently.

#### Replacing headlamp bulbs

1. Make sure the headlamp control is in the off position and open the hood.
2. Remove four push pins from the radiator grille and pull the grille forward to access the lower screw.
3. Remove three bolts and washers from the headlamp assembly.
4. Carefully pull the headlamp assembly up and away from the vehicle to disengage the spring clip located on the bottom of the headlamp assembly.
5. Disconnect electrical connector from the bulb.

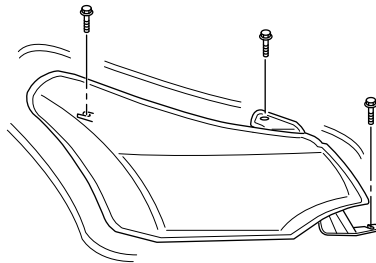

## Lights

6. Remove bulb from the headlamp assembly by turning it counterclockwise, then pull it straight out.

Install the new bulb in reverse order.

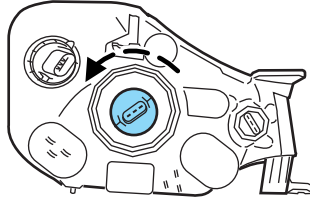

**! WARNING:** Handle a halogen headlamp bulb carefully and keep out of children's reach. Grasp the bulb by only its plastic base and do not touch the glass. The oil from your hand could cause the bulb to break the next time the headlamps are operated.

**Note:** If the bulb is accidentally touched, it should be cleaned with rubbing alcohol before being used.

### **Replacing front parking lamp/turn signal bulbs**

1. Make sure the headlamp control is in the off position and open the hood.

2. Remove four push pins from the radiator grille and pull the grille forward to access the lower screw.

3. Remove three bolts and washers from the headlamp assembly.

4. Carefully pull the headlamp assembly up and away from the vehicle to disengage the spring clip located on the bottom of the headlamp assembly.

5. Remove the bulb socket from the lamp assembly by turning counterclockwise.

6. Pull the bulb straight out of the socket.

Install the new bulb in reverse order.

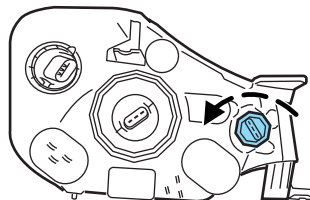
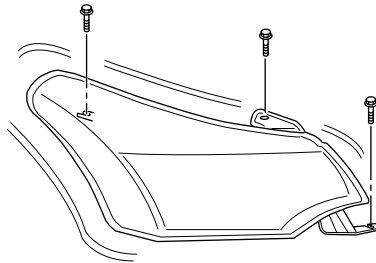

## Lights

### Replacing side marker bulbs

1. Make sure the headlamp control is in the off position and open the hood.
2. Remove four push pins from the radiator grille and pull the grille forward to access the lower screw.
3. Remove three bolts and washers from the headlamp assembly.
4. Carefully pull the headlamp assembly up and away from the vehicle to disengage the spring clip located on the bottom of the headlamp assembly.
5. Remove the bulb socket from the lamp assembly by turning counterclockwise.
6. Pull the bulb straight out of the socket.

Install the new bulb in reverse order.

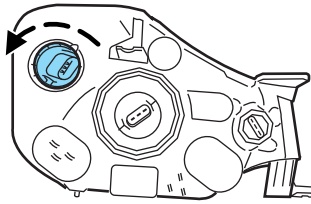
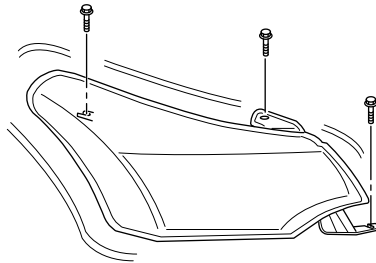

### Replacing tail/brake/backup lights and turn signal bulbs

1. Make sure the headlamp control is in the off position and then open the trunk.
2. Remove two plastic screws and cover from inside the luggage compartment.
3. Remove two nuts from the lamp assembly.
4. Gently pull the lamp assembly away from the vehicle.
5. Turn the bulb socket counterclockwise and pull it out.
6. Pull the bulb straight out of the socket.

Install the new bulb in reverse order.

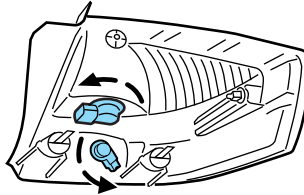

### **Replacing fog lamp bulbs (if equipped)**

1. Make sure the headlamp switch is in the off position.
2. Reach under the front fender, and remove the harness/bulb assembly from the fog lamp by turning counterclockwise.
3. Disconnect the harness from the bulb by pulling it straight off.

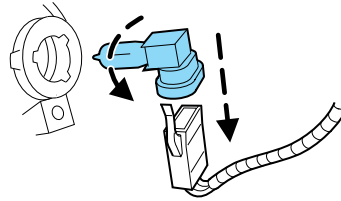

Install the new bulb in reverse order.

### **Replacing license plate lamp bulbs**

1. Make sure the headlamp switch is in the off position.
2. Remove the two screws and the lens from the license plate lamp assembly.
3. Carefully pull the bulb straight out from the lamp assembly.

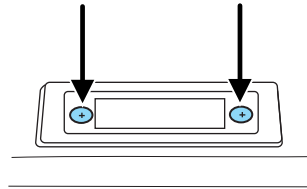

Install new bulb(s) in reverse order.

### **Replacing high-mount brake lamp assembly**

Your vehicle is equipped with an LED center high-mount stop lamp. It is designed to last the life of the vehicle. If replacement is required, it is recommended that you see your authorized dealer.

## Driver Controls

### MULTI-FUNCTION LEVER

**Windshield wiper:** Rotate the end of the control away from you to increase the speed of the wipers; rotate towards you to decrease the speed of the wipers.

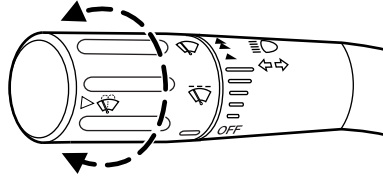

**Windshield washer:** Push the end of the stalk:

- briefly: causes a single swipe of the wipers without washer fluid.
- a quick push and hold: the wipers will swipe three times with washer fluid.
- a long push and hold: the wipers and washer fluid will be activated for up to ten seconds.

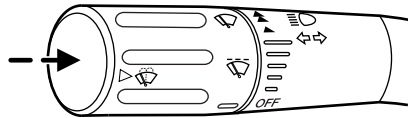

**Courtesy wipe feature:** One extra wipe will happen a few seconds after washing the front window to clear any water that is dripping down from the top of the windshield caused by the washing.

**Note:** Do not operate the washer when the washer reservoir is empty. This may cause the washer pump to overheat. Check the washer fluid level frequently. Do not operate the wipers when the windshield is dry. This may scratch the glass, damage the wiper blades and cause the wiper motor to burn out. Before operating the wiper on a dry windshield, always use the windshield washer. In freezing weather, be sure the wiper blades are not frozen to the windshield before operating the wipers.



## Driver Controls

### TILT STEERING WHEEL

To adjust the steering wheel:

1. Pull the lever down to unlock the steering column.
2. While the lever is in the down position, move the steering wheel up or down until you find the desired position.
3. While holding the steering wheel in place, pull the lever up to its original position to lock the steering column.

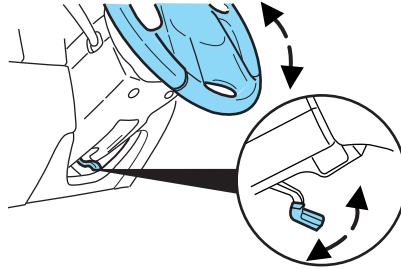

**WARNING:** Never adjust the steering wheel when the vehicle is moving.

### ELECTRONIC COMPASS (IF EQUIPPED)

The compass heading is displayed as one of N, NE, E, SE, S, SW, W and NW in the center stack display.

The compass reading may be affected when you drive near large buildings, bridges, power lines and powerful broadcast antenna. Magnetic or metallic objects placed in, on or near the vehicle may also affect compass accuracy.

Usually, when something affects the compass readings, the compass will correct itself after a few days of operating your vehicle in normal conditions. If the compass still appears to be inaccurate, a manual calibration may be necessary. Refer to *Compass zone adjustment*.

Most geographic areas (zones) have a magnetic north compass point that varies slightly from the northerly direction on maps. This variation is four degrees between adjacent zones and will become noticeable as the vehicle crosses multiple zones. A correct zone setting will eliminate this error. Refer to *Compass calibration adjustment*.

## Driver Controls

### Compass zone adjustment

1. Determine which magnetic zone you are in for your geographic location by referring to the zone map.

2. Turn ignition to the on position.

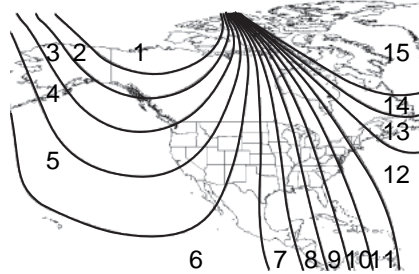

3. Press and hold the 7 and 9 radio preset buttons together for approximately five seconds until ZONE XX appears in the CID.

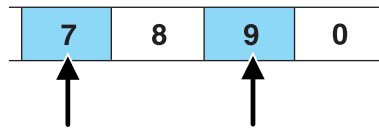

4. Press and release the 7 and 9 radio preset buttons together, repeatedly until ZONE XX changes to the correct zone (1–15) in the CID.

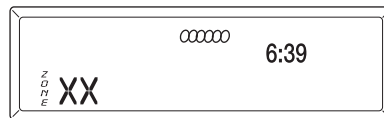

5. The direction will display after the buttons are released. The zone is now updated.

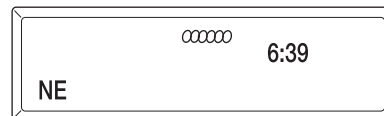

### Compass calibration adjustment

Perform compass calibration in an open area free from steel structures and high voltage lines. For optimum calibration, turn off all electrical accessories (heater/air conditioning, wipers, etc.) and make sure all vehicle doors are shut.

1. Start the vehicle.

## Driver Controls

2. To calibrate, press and hold the 7 and 9 radio preset buttons together for approximately 10 seconds until CAL appears. Release the buttons.

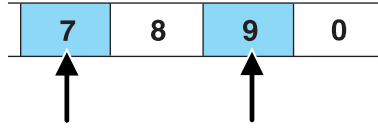

3. Slowly drive the vehicle in a circle (less than 3 mph [5 km/h]) until the CAL display changes to the direction value (N, S, E, W, etc.). It may take up to five circles to complete calibration.

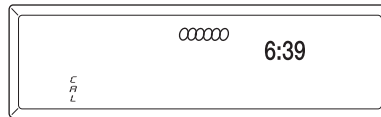

4. The compass is now calibrated.

### CENTER CONSOLE

Your vehicle has a variety of console features. These include:

- Cupholders
- Utility compartment



**WARNING:** Use only soft cups in the cupholder. Hard objects can injure you in a collision.

### AUXILIARY POWER POINT (12VDC)

**Power outlet is designed for accessory plugs only. Do not insert any other object in the power outlet as this will damage the outlet and blow the fuse. Do not hang any type of accessory or accessory bracket from the plug. Improper use of the power outlet can cause damage not covered by your warranty.**

The auxiliary power points are located on the instrument panel.

Do not use the power point for operating the cigarette lighter element (if equipped).

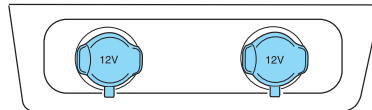

To prevent the fuse from being blown, do not use the power point(s) over the vehicle capacity of 12 VDC/180W. If the power point or cigar lighter socket is not working, a fuse may have blown. Refer to *Fuses and relays* in the *Roadside Emergencies* chapter for information on checking and replacing fuses.

## Driver Controls

To have full capacity usage of your power point, the engine is required to be running to avoid unintentional discharge of the battery. To prevent the battery from being discharged:

- do not use the power point longer than necessary when the engine is not running,
- do not leave battery chargers, video game adapters, computers and other devices plugged in overnight or when the vehicle is parked for extended periods.

Always keep the power point caps closed when not being used.

### Cigar lighter (if equipped)

Do not plug optional electrical accessories into the cigarette lighter socket.

Do not hold the lighter in with your hand while it is heating, this will damage the lighter element and socket. The lighter will be released from its heating position when it is ready to be used.

**Note:** Improper use of the lighter can cause damage not covered by your warranty, and can result in fire or serious injury.

## POWER WINDOWS



**WARNING:** Do not leave children unattended in the vehicle and do not let children play with the power windows. They may seriously injure themselves.



**WARNING:** When closing the power windows, you should verify they are free of obstructions and ensure that children and/or pets are not in the proximity of the window openings.

Press and pull the window switches to open and close windows.

- Push down (to the first detent) and hold the switch to open.
- Pull up (to the first detent) and hold the switch to close.

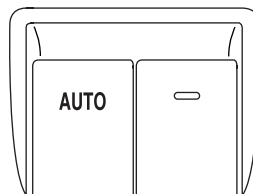

## Driver Controls

### One touch down (AUTO)

Allows the driver's window to open fully without holding the control down. Push the switch completely down to the second detent and release quickly. The window will open fully. Momentarily press the switch to any position to stop the window operation.

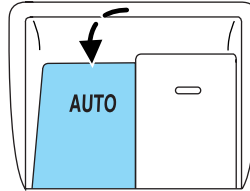

### Window lock (if equipped)

The window lock feature allows only the driver to operate the power windows.

To lock out all the window controls (except for the driver's) press the right side of the control. Press the left side to restore the window controls.

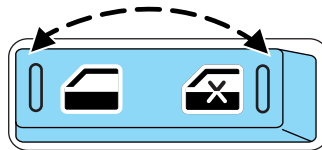

### INTERIOR MIRROR

The interior rear view mirror has two pivot points on the support arm which lets you adjust the mirror UP or DOWN and from SIDE to SIDE.



**WARNING:** Do not adjust the mirror while the vehicle is in motion.

### Automatic dimming interior rear view mirror (if equipped)

Your vehicle may be equipped with an interior rear view mirror which has an auto-dimming function. The electronic day/night mirror will change from the normal (high reflective) state to the non-glare (darkened) state when bright lights (glare) reach the mirror. When the mirror detects bright light from behind the vehicle, it will automatically adjust (darken) to minimize glare.

The mirror will automatically return to the normal state whenever the vehicle is placed in R (Reverse) to ensure a bright clear view when backing up.

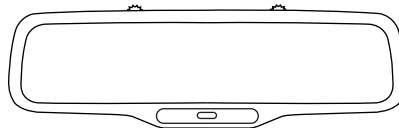

## Driver Controls

**Do not block the sensors on the front and back of the interior rear view mirror since this may impair proper mirror performance.**

**Do not clean the housing or glass of any mirror with harsh abrasives, fuel or other petroleum-based cleaning products.**

### EXTERIOR MIRRORS

**Power side view mirrors (if equipped)** 



**WARNING:** Do not adjust the mirror while the vehicle is in motion.

To adjust your mirrors:

1. Rotate the control clockwise to adjust the right mirror and rotate the control counterclockwise to adjust the left mirror.
2. Move the control in the direction you wish to tilt the mirror.
3. Return to the center position to lock mirrors in place.

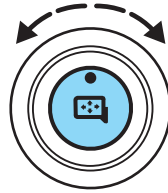

### Heated outside mirrors (if equipped)

Both mirrors are heated automatically to remove ice, mist and fog when the rear window defrost is activated.

**Do not remove ice from the mirrors with a scraper or attempt to readjust the mirror glass if it is frozen in place.**

**These actions could cause damage to the glass and mirrors.**

**Do not clean the housing or glass of any mirror with harsh abrasives, fuel or other petroleum-based cleaning products.**

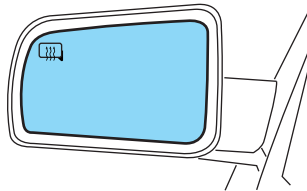

### SPEED CONTROL (IF EQUIPPED)

With speed control set, you can maintain a set speed without keeping your foot on the accelerator pedal.

## Driver Controls





**WARNING:** Do not use the speed control in heavy traffic or on roads that are winding, slippery or unpaved.

### Setting speed control

The controls for using your speed control are located on the steering wheel for your convenience.

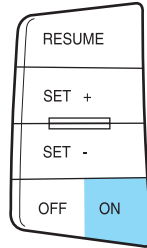
1. Press the ON control and release it.
2. Accelerate to the desired speed.



3. Press the SET + control and release it.
4. Take your foot off the accelerator pedal.
5. The indicator light  on the instrument cluster will turn on.

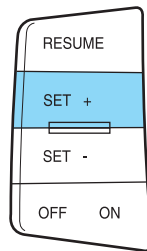

### Note:

- Vehicle speed may vary momentarily when driving up and down a steep hill.
- If the vehicle speed increases above the set speed on a downhill, you may want to apply the brakes to reduce the speed.
- If the vehicle speed decreases more than 10 mph (16 km/h) below your set speed on an uphill, your speed control will disengage.

### Disengaging speed control

To disengage the speed control:

- Depress the brake pedal or
- Depress the clutch pedal (if equipped).

Disengaging the speed control will not erase previous set speed.

## Driver Controls

**Note:** When you use the clutch pedal to disengage the speed control, the engine speed may briefly increase, this is normal.

### **Resuming a set speed**

Press the RESUME control and release it. This will automatically return the vehicle to the previously set speed.

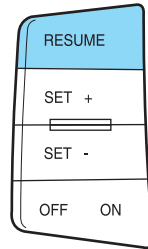

### **Increasing speed while using speed control**

There are three ways to set a higher speed:

- Press and hold the SET + control until you get to the desired speed, then release the control.
- Press and release the SET + control to operate the Tap-Up function. Each tap will increase the set speed by 1 mph (1.6 km/h).
- Use the accelerator pedal to get to the desired speed. When the vehicle reaches that speed, press and release the SET + control.

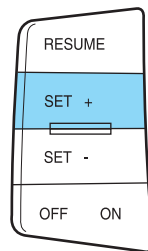

### **Reducing speed while using speed control**

There are three ways to reduce a set speed:

- Press and hold the SET - control until you get to the desired speed, then release the control.
- Press and release the SET - control to operate the Tap-Down function. Each tap will decrease the set speed by 1 mph (1.6 km/h).

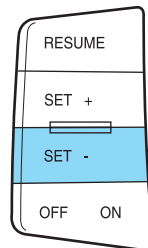



## Driver Controls

- Depress the brake pedal until the desired vehicle speed is reached, press the SET + control.

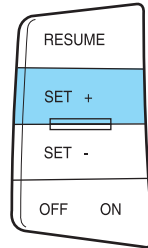

### Turning off speed control

There are two ways to turn off the speed control:

- Press the speed control OFF control.
- Turn off the ignition.

**Note:** When you turn off the speed control or the ignition, your speed control set speed memory is erased.

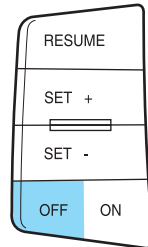

## STEERING WHEEL CONTROLS (IF EQUIPPED)

### Radio control features

Press MEDIA to select:

- AM, FM1, FM2, or CD
- SAT1, SAT2 or SAT3 (Satellite Radio mode if equipped).
- LINE IN (Auxiliary input jack) (if equipped)

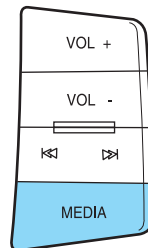

## Driver Controls

### In AM, FM1, or FM2 mode:

- Press **⏪ ⏩** to access the next/previous preset station.

### In Satellite radio mode (if equipped):

- Press **⏪ ⏩** to advance through preset channels.

### In CD mode:

- Press **⏪ ⏩** to listen to the next track on the disc.

### In any mode:

- Press VOL + or VOL - to adjust the volume.

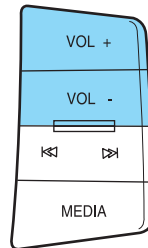
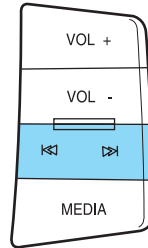

### SYNC hands free control feature (if equipped)

Press **📞** briefly to use the voice command feature. You will hear a tone and LISTENING will appear in the radio display. Press and hold **📞** to exit voice command.

Press **📞** to activate phone mode or answer a phone call. Press and hold **📞** to end call or exit phone mode.

Press **⏪ ⏩** to scroll through various menus and selections. Press OK to confirm your selection.

For further information on the SYNC system, refer to the SYNC supplement.

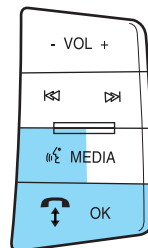

## Driver Controls

### MOON ROOF (SUNROOF) (IF EQUIPPED)

You can move the glass panel of the moon roof back to open or tilt up to ventilate the vehicle.



**WARNING:** Do not let children play with the moon roof or leave children unattended in the vehicle. They may seriously hurt themselves.

The moon roof is equipped with an automatic, one-touch, express opening and closing feature. To stop motion at any time during the one-touch operation, press the control a second time.

**Note:** The moon roof will open to the “**comfort**” position first before opening all the way. The “**comfort**” position helps to alleviate rumbling wind noise which may happen in the vehicle with the roof fully opened.

**To open the moon roof:** Press and release the SLIDE control. The moon roof will open to the “**comfort**” position. Press and release the control again to fully open. Press the switch again to stop the moon roof.

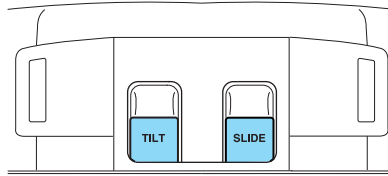

**WARNING:** When closing the moon roof, you should verify that it is free of obstructions and ensure that children and/or pets are not in the proximity of the moon roof opening.

**To close the moon roof:** Pull and release the SLIDE control, the moon roof will close automatically. Press the switch again to stop the moon roof.

**Bounce-back:** When an obstacle has been detected in the moon roof opening as the moon roof is closing, the moon roof will automatically open and stop at a prescribed position.

**Bounce-back override:** To override bounce-back function, pull and hold the SLIDE switch within two seconds of a bounce-back event. The closing force will begin to increase each time the moon roof is closed for the first three closing cycles, with bounce-back active. For example: Bounce-back can be used to overcome the resistance of ice on the moon roof or seals

## Driver Controls

**To vent the moon roof:** Press and release the TILT control, the moon roof will move to the vent position automatically from any moon roof position. Press the switch again to stop the moon roof. Pull and hold the TILT control to close the moon roof.

The moon roof has a built-in sliding shade that can be manually opened or closed when the glass panel is shut. To close the shade, pull it toward the front of the vehicle.

**Relearning function:** In case the moon roof does not close properly anymore, follow this relearning procedure.

- Tilt the moon roof into the vent position as far as possible. Release the switch.
- Press and hold the same switch again for 30 seconds until you see the moon roof move.
- Release the switch and immediately press and hold it again. The moon roof will close, open fully and then close again. Do not release the switch before the moon roof has reached the closed position for the second time.

**Safety mode:** If the system detects a malfunction, it enters a safety mode. The moon roof will move about 0.5 seconds at a time and then stop again. Press the switch repeatedly until the moon roof is closed. Have the system checked by your authorized dealer immediately.

### MESSAGE CENTER (IF EQUIPPED)

With the ignition in the on position, the message center, located on your instrument cluster, displays important vehicle information

**through a constant monitor of vehicle systems.** You may select

display features on the message center for a display of status. The system will also notify you of potential vehicle problems with a display of system warnings followed by a long indicator chime.



XXXXXXXXXXXXXXXXXX  
XXXXXXXXXXXXXXXXXX

## Driver Controls

### Selectable features

#### Reset

Press this control to select and reset functions shown in the INFO menu and SETUP menu.

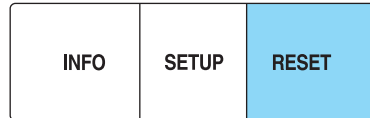

#### Info menu

This control displays the following control displays:

- Odometer/Trip Odometer A or B
- Distance to Empty
- Average Fuel Economy
- Instantaneous Fuel Economy
- Blank (odometer off)



#### Odometer/Trip odometer

Refer to *Gauges* in the *Instrument Cluster* chapter.

#### Distance to empty (DTE)

Selecting this function from the INFO menu will give you an estimate of how far you can drive with the fuel remaining in your tank under normal driving conditions.

Remember to turn the ignition off when refueling your vehicle. Otherwise, the display will not show the addition of fuel for a few miles (kilometers). DTE will vary according to your driving habits.



#### Average fuel economy (AFE)

Select this function from the INFO menu to display your average fuel economy in miles/gallon or liters/100 km.



## Driver Controls

If you calculate your average fuel economy by dividing miles traveled by gallons of fuel used (liters of fuel by used 100 kilometers traveled), your figure may be different than displayed for the following reasons:

- your vehicle was not perfectly level during fill-up
- differences in the automatic shut-off points on the fuel pumps at service stations
- variations in top-off procedure from one fill-up to another
- rounding off the displayed values to the nearest 0.1 gallon (liter)

1. Drive the vehicle at least 5 miles (8 km) with the speed control system engaged to display a stabilized average.

2. Record the highway fuel economy for future reference.

It is important to press the RESET control after setting the speed control to get accurate highway fuel economy readings.

### **Instantaneous fuel economy**

Select this function from the INFO menu to display your instantaneous fuel economy. This will display your fuel economy as a bar graph ranging from ▼ poor economy to ▲ excellent economy.



Your vehicle must be moving to calculate instantaneous fuel economy. When your vehicle is not moving, this function shows ▼, one or no bars illuminated. Instantaneous fuel economy cannot be reset.

### **Setup menu**

Press this control for the following displays:

- Reset to English (if in another language)
- System Check
- Units (English/Metric)
- Autolock (if equipped)
- Autounlock (if equipped)
- Language

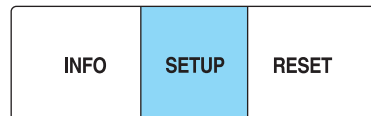

## Driver Controls

### **Reset to English (if in another language)**

When entering the SETUP MENU and a non-English language has been selected, "HOLD RESET FOR ENGLISH" will be displayed to change back to English.



HOLD RESET FOR  
ENGLISH

Hold the RESET control to change back to English.

### **System check**

Selecting this function from the SETUP menu causes the message center to cycle through each of the systems being monitored. For each of the monitored systems, the message center will indicate either an OK message or a warning message for three seconds.



RESET FOR  
SYSTEM CHECK

Pressing the RESET control cycles the message center through each of the systems being monitored.

The sequence of the system check report is as follows:

1. CHARGING SYSTEM
2. DOORS
3. TRUNK
4. BRAKE SYSTEM
5. DTE/FUEL LEVEL

### **Units (English/Metric)**

1. Select this function from the SETUP menu for the current units to be displayed.
2. Press the RESET control to change from English to Metric.



UNITS  
< ENG > METRIC

### **Autolock**

This feature automatically locks all vehicle doors when the vehicle is shifted into any gear, putting the vehicle in motion.

## Driver Controls

1. To disable/enable the autolock feature, select this function from the SETUP control for the current display mode.

AUTOLOCK  
< ON > OFF

2. Press the RESET control to turn the autolock ON or OFF.

### **Autounlock**

This feature automatically unlocks all vehicle doors when the driver's door is opened within 10 minutes of the ignition being turned off.

1. To disable/enable the autounlock feature, select this function from the SETUP control for the current display mode.

AUTOUNLOCK  
< ON > OFF

2. Press the RESET control switch to turn the autounlock ON or OFF.

### **Language**

1. Select this function from the SETUP menu for the current language to be displayed.

LANGUAGE =  
ENGLISH

2. Waiting four seconds or pressing the RESET control cycles the message center through each of the language choices.

Selectable languages are English, Spanish, or French.

3. Press and hold the RESET control for two seconds to set the language choice.

### **System warnings**

System warnings alert you to possible problems or malfunctions in your vehicle's operating systems.

In the event of a multiple warning situation, the message center will cycle the display to show all warnings by displaying each one for four seconds.

The message center will display the last selected feature if there are no more warning messages. This allows you to use the full functionality of the message center after you acknowledge the warning by pressing the RESET control and clearing the warning message.



## Driver Controls

Warning messages that have been reset are divided into two categories:

- They will reappear on the display 10 minutes from the reset.
- They will not reappear until an ignition off-on cycle has been completed.

This acts as a reminder that these warning conditions still exist within the vehicle.

Warnings	Status
Driver door ajar	Warning cannot be reset
Passenger door ajar	
Rear left door ajar (if equipped)	
Rear right door ajar (if equipped)	
Park brake engaged	Warning returns after 10 minutes if condition still exists
XXX miles to E fuel level low	
Check brake system	Warning returns after the ignition key is turned from off to on.
Brake fluid level low	
Low tire pressure	
Tire pressure monitor fault	
Tire pressure sensor fault	

**DRIVER DOOR AJAR** — Displayed when the driver door is not completely closed.

**PASSENGER DOOR AJAR** — Displayed when the passenger door is not completely closed.

**REAR LEFT DOOR AJAR** — Displayed when the rear left door is not completely closed.

**REAR RIGHT DOOR AJAR** — Displayed when the rear right door is not completely closed.

**PARK BRAKE ENGAGED** — Displayed when the manual park brake is set. If the warning stays on after the park brake is released, contact your authorized dealer as soon as possible.

**XXX MILES TO E FUEL LEVEL LOW** — Displayed as an early reminder of a low fuel condition.

**CHECK BRAKE SYSTEM** — Displayed when the braking system is not operating properly. If the warning stays on or continues to come on, contact your authorized dealer as soon as possible.

## Driver Controls

**BRAKE FLUID LEVEL LOW** — Indicates the brake fluid level is low and the brake system should be inspected immediately. Refer to *Brake/clutch fluid* in the *Maintenance and Specifications* chapter.

**LOW TIRE PRESSURE** — Displayed when one or more tires on your vehicle have low tire pressure. Refer to *Inflating your tires* in the *Tires, Wheels and Loading* chapter.

**TIRE PRESSURE MONITOR FAULT** — Displayed when the Tire Pressure Monitoring System is malfunctioning. If the warning stays on or continues to come on, contact your authorized dealer as soon as possible.

**TIRE PRESSURE SENSOR FAULT** — Displayed when a tire pressure sensor is malfunctioning, or your spare tire is in use. For more information on how the system operates under these conditions, refer to *Tire Pressure Monitoring System (TPMS)* in the *Tires, Wheels and Loading* chapter. If the warning stays on or continues to come on, contact your authorized dealer as soon as possible.

### REMOTE LUGGAGE COMPARTMENT RELEASE (IF EQUIPPED)

To open the luggage compartment, press the control on the instrument panel located to the left of the cluster.

The control does not function if the vehicle is traveling faster than 4 mph (7 km/h).

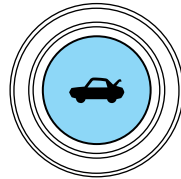

## Driver Controls

### POSITIVE RETENTION FLOOR MAT

 **WARNING:** Do not install additional floor mats on top of the factory installed floor mats as they may interfere with the accelerator or the brake pedals.

Position the floor mat so the eyelet is over the pointed end of the retention post and then pull eyelet over and push floor mat down over retention post. Properly align mat in drivers footwell, rotating if necessary. Make sure the mat does not interfere with the operation of the accelerator, brake pedal or clutch pedal (if equipped). To remove the floor mat, reverse the installation procedure.

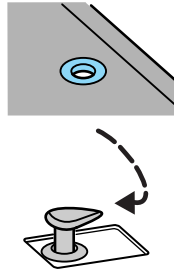



## Locks and Security

### KEYS

One key operates all the locks and starts the vehicle. Always carry a spare key with you in case of an emergency.

Your keys are programmed to your vehicle; using a non-programmed key will not permit your vehicle to start. If you lose your authorized dealer supplied keys, replacement keys are available through your authorized dealer. Refer to the *SecuriLock™ passive anti-theft system* section later in this chapter for more information.

### POWER DOOR LOCKS

- Press the  control to unlock all doors.
- Press the  control to lock all doors.

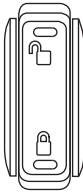

### Smart locks

This feature helps to prevent you from locking yourself out of the vehicle if your key is still in the ignition.

When you open one of the front doors and you lock the vehicle with the power door lock control (on the driver or passenger door trim panel), all the doors will lock, then all doors will automatically unlock reminding you that your key is still in the ignition.

The vehicle can still be locked, with the key in the ignition, by locking the driver's door with a key or using the lock control on the remote entry key fob.

If both front doors are closed, the vehicle can be locked from any method, regardless of whether the key is in the ignition or not.

### Autolock (if equipped)

The autolock feature will lock all the doors when:

- all doors are closed,
- the ignition is in the on position,
- you shift into any gear putting the vehicle in motion, and
- the vehicle attains a speed greater than 12 mph (20 km/h).

## Locks and Security

The autolock feature repeats when:

- any door is opened then closed while the ignition is in the on position and the vehicle speed is 9 mph (15 km/h) or lower, and
- the vehicle attains a speed greater than 12 mph (20 km/h).

### ***Deactivating/activating autolock***

Your vehicle comes with the autolock feature enabled. There are three methods to enable/disable this feature:

- Through your authorized dealer, or
- Performing the power door lock control procedure, or
- Performing the message center (if equipped) procedure. Refer to *Message center* in the *Driver Controls* chapter.



**Note:** The autolock feature can be activated/deactivated independently of the autounlock feature.

Before following the activation or deactivation procedures, make sure that the anti-theft system is not armed, ignition is in the off position, and all vehicle doors are closed.

## Locks and Security

### **Power door unlock/lock procedure**

Before starting, ensure the ignition is in the off position and all vehicle doors are closed. You must complete Steps 1–5 within 30 seconds or the procedure will have to be repeated. If the procedure needs to be repeated, wait a minimum of 30 seconds before beginning again.

1. Place the key in the ignition and turn the ignition to the on position.
2. Press the power door  control on the door panel three times.
3. Turn the ignition from the on position to the off position.
4. Press the power door  control on the door panel three times.
5. Turn the ignition back to the on position. The horn will chirp one time to confirm programming mode has been entered and is active.
6. To enable/disable the autolock feature, press the unlock control, then press the lock control. The horn will chirp once if autolock was deactivated or twice (one short and one long chirp) if autolock was activated.
7. Turn the ignition to the off position. The horn will chirp once to confirm the procedure is complete.

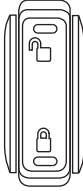

### **Autounlock feature (if equipped)**

The autounlock feature will unlock all the doors when:

- the ignition is in the on position, all the doors are closed, and the vehicle has been in motion at a speed greater than 12 mph (20 km/h);
- the vehicle has then come to a stop and the ignition is turned to the off or accessory position; and
- the driver door is opened within 10 minutes of the ignition being transitioned to the off or accessory position.

**Note:** The doors will not autounlock if the vehicle has been electronically locked before the driver door is opened.

## Locks and Security

### **Deactivating/activating autounlock feature**



Your vehicle comes with the autounlock features activated; there are three methods to enable/disable this feature:

- Through your authorized dealer,
- by using a power door unlock/lock sequence
- or by using the instrument cluster message center. Refer to *Message center* in the *Driver Controls* chapter.

**Note:** The autounlock feature can be activated/deactivated independently of the autolock feature.

### **Power door lock switch autounlock enable/disable procedure**

Before starting, ensure the ignition is in the off position and all vehicle doors are closed. You must complete Steps 1–5 within 30 seconds or the procedure will have to be repeated. If the procedure needs to be repeated, wait a minimum of 30 seconds before beginning again.

1. Place the key in the ignition and turn the ignition to the on position.
2. Press the power door  control on the door panel three times.
3. Turn the ignition from the on position to the off position.
4. Press the power door  control on the door panel three times.
5. Turn the ignition back to the on position. The horn will chirp one time to confirm programming mode has been entered and is active.
6. To enable/disable the autounlock feature, press the lock control, then press the unlock control. The horn will chirp once if autounlock was deactivated or twice (one short and one long chirp) if autounlock was activated.
7. Turn the ignition to the off position. The horn will chirp once to confirm the procedure is complete.

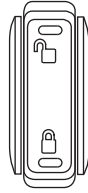

## Locks and Security

### CHILDPROOF DOOR LOCKS

- When these locks are set, the rear doors cannot be opened from the inside.
- The rear doors can be opened from the outside when the doors are unlocked.

The childproof locks are located on rear edge of each rear door and must be set separately for each door. Setting the lock for one door will not automatically set the lock for both doors.

- Insert the key and turn to the lock position (key horizontal) to engage the childproof locks.
- Insert the key and turn to the unlock position (key vertical) to disengage the childproof locks.

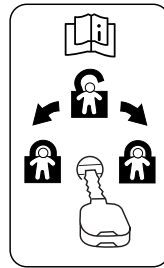
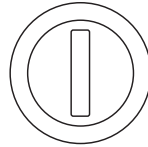

### INTERIOR LUGGAGE COMPARTMENT RELEASE

Your vehicle is equipped with a mechanical interior luggage compartment release handle that provides a means of escape for children and adults in the event they become locked inside the luggage compartment.

Adults are advised to familiarize themselves with the operation and location of the release handle.



## Locks and Security

To open the luggage compartment door (lid) from within the luggage compartment, pull the illuminated “T” shaped handle and push up on the trunk lid. The handle is composed of a material that will glow for hours in darkness following brief exposure to ambient light.

The “T” shaped handle will be located either on the luggage compartment door (lid) or inside the luggage compartment near the tail lamps.

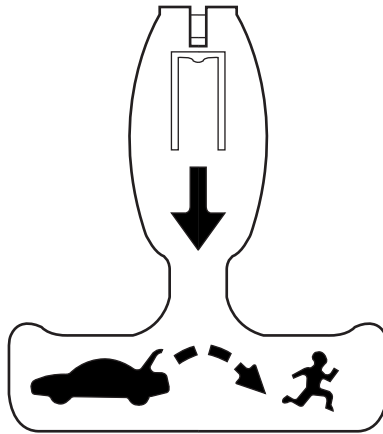

**WARNING:** Keep vehicle doors and luggage compartment locked and keep keys and remote transmitters out of a child's reach. Unsupervised children could lock themselves in the trunk and risk injury. Children should be taught not to play in vehicles.

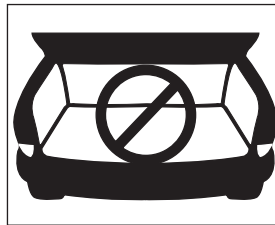

**WARNING:** Do not leave children, unreliable adults, or animals unattended in the vehicle. On hot days, the temperature in the trunk or vehicle interior can rise very quickly. Exposure of people or animals to these high temperatures for even a short time can cause death or serious heat-related injuries, including brain damage. Small children are particularly at risk.

## Locks and Security

### REMOTE ENTRY SYSTEM (IF EQUIPPED)

This device complies with part 15 of the FCC rules and with RSS-210 of Industry Canada. Operation is subject to the following two conditions: (1) This device may not cause harmful interference, and (2) This device must accept any interference received, including interference that may cause undesired operation.

**Changes or modifications not expressly approved by the party responsible for compliance could void the user's authority to operate the equipment.**

The typical operating range for your remote entry transmitter is approximately 33 feet (10 meters). A decrease in operating range could be caused by:

- weather conditions,
- nearby radio towers,
- structures around the vehicle, or
- other vehicles parked next to your vehicle.

Your vehicle may have an all-door remote entry system.

The all-door remote entry system allows you to:



- lock or unlock all vehicle doors without a key.
- open the luggage compartment without a key.
- activate the panic alarm.



The remote entry lock/unlock feature operates in any ignition position except start. The panic feature operates with the key in the off position.

If there are problems with the remote entry system, make sure to take **ALL remote entry transmitters** with you to the authorized dealer in order to aid in troubleshooting the problem.

### Unlocking the doors





1. Press  and release to unlock the driver's door. **Note:** The interior lamps will illuminate.
2. With the all-door remote entry, press  and release again within three seconds to unlock all the doors.

## Locks and Security



The remote entry system activates the illuminated entry feature. This feature turns on the interior lamps for 25 seconds or until the ignition is turned to the on position. The dome lamp control must be set to the **ON** position in order for the illuminated entry feature to operate.

### **Programming unlocking mode (if equipped)**

The unlocking mode (if equipped) on the remote entry transmitter can be programmed. To change the unlocking mode from the single-door unlocking mode to the central all-door unlocking mode:

- With the vehicle in the off position, press the  and  on the remote entry transmitter simultaneously and hold for four seconds. The park/turn lamps will flash twice to indicate the mode change.
- Press the  and  on the remote entry transmitter simultaneously and hold for four seconds to toggle between unlocking modes.

### **Locking the doors**

- Press  and release to lock all doors. **Note:** The park/turn lamps will flash once. If any door or trunk is ajar, the lamps will not flash. Once the door that was ajar is closed, the lamps will flash to indicate that the vehicle is locked and all doors are closed.
- Press  and release a second time to confirm all doors have locked. **Note:** The horn will honk once and the park/turn lamps will flash if all doors are closed. The horn will honk twice if any door is ajar.

### **Car finder**

Press  twice within three seconds. The horn will chirp and the turn lamps will flash. It is recommended that this method be used to locate your vehicle, rather than using the panic alarm.

### **Sounding a panic alarm**

Press  to activate the alarm. Press again or turn the ignition to the on or accessory position to deactivate, or wait for the alarm to time out in three minutes.

**Note:** The panic alarm will only operate when the ignition is in the off position.

## Locks and Security

### Opening the luggage compartment

Press  once to open the luggage compartment. **Note:** This feature will only operate with the ignition in the off or the accessory position.

- Ensure that the trunk is closed and latched before driving your vehicle. Failure to properly latch the trunk may cause objects to fall out or block the driver's rear view.

### Replacing the battery

The remote entry transmitter uses one coin type three-volt lithium battery CR2032 or equivalent.

To replace the battery:

1. Twist a thin coin between the two halves of the remote entry transmitter near the key ring. **DO NOT TAKE THE RUBBER COVER AND CIRCUIT BOARD OFF THE FRONT HOUSING OF THE REMOTE ENTRY TRANSMITTER.**

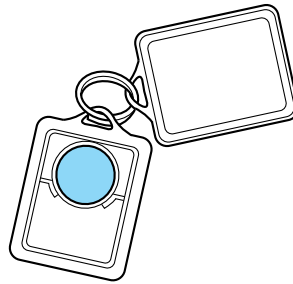

2. Do not wipe off any grease on the battery terminals on the back surface of the circuit board.
3. Remove the old battery.

**Note:** Please refer to local regulations when disposing of transmitter batteries.

4. Insert the new battery. Refer to the diagram inside the remote entry transmitter for the correct orientation of the battery. Press the battery down to ensure that the battery is fully seated in the battery housing cavity.
5. Snap the two halves back together.

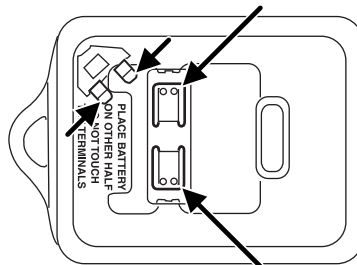

## Locks and Security

### Replacing lost remote entry transmitters

If you would like to have your remote entry transmitter reprogrammed because you lost one, or would like to buy additional remote entry transmitters, you can either reprogram them yourself, or take **all remote entry transmitters** to your authorized dealer for reprogramming.

### How to reprogram your remote entry transmitters

You must have **all remote entry transmitters** (maximum of four) available before beginning this procedure. If all remote entry transmitters are not present during the programming procedure, the transmitters that are not present during programming will no longer operate the vehicle.

**Note:** Ensure the brake pedal is not depressed during this sequence.

To reprogram the remote entry transmitters:

1. Ensure the vehicle is electronically unlocked.
2. Put the key in the ignition.
3. Turn the key from the 1 (off) position to 3 (on).

4. Cycle eight times rapidly (within 10 seconds) between the 1 (off) position and 3 (on).

**Note:** The eighth turn must end in the 3 (on) position.

5. The doors will lock, then unlock, to confirm that the programming mode has been activated.
6. Within 20 seconds press any button on the remote entry transmitter.  
**Note:** If more than 20 seconds have passed you will need to start the procedure over again.
7. The doors will lock, then unlock, to confirm that this remote entry transmitter has been programmed.
8. Repeat Step 6 to program each additional remote entry transmitter.
9. Turn the ignition to the 1 (off) position after you have finished programming all of the remote entry transmitters.

10. The doors will lock, then unlock, to confirm that the programming mode has been exited.

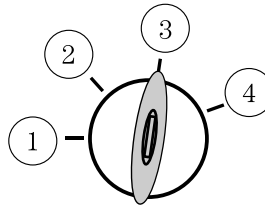

## Locks and Security

### SECURILOCK™ PASSIVE ANTI-THEFT SYSTEM

SecuriLock™ passive anti-theft system is an engine immobilization system. This system is designed to help prevent the engine from being started unless a **coded key programmed to your vehicle** is used. The use of the wrong type of coded key may lead to a “no-start” condition.

Your vehicle comes with two coded keys; additional coded keys may be purchased from your authorized dealer. The authorized dealer can program your spare keys to your vehicle or you can program the keys yourself. Refer to *Programming spare keys* for instructions on how to program the coded key.

**Note:** The SecuriLock™ passive anti-theft system is not compatible with non-Ford aftermarket remote start systems. Use of these systems may result in vehicle starting problems and a loss of security protection.

**Note:** Large metallic objects, electronic devices that are used to purchase gasoline or similar items, or a second coded key on the same key chain may cause vehicle starting issues. You need to prevent these objects from touching the coded key while starting the engine. These objects will not cause damage to the coded key, but may cause a momentary issue if they are too close to the key when starting the engine. If a problem occurs, turn the ignition off, remove all objects on the key chain away from the coded key and restart the engine.

**Note: Do not leave a duplicate coded key in the vehicle. Always take your keys and lock all doors when leaving the vehicle.**

#### Anti-theft indicator

The anti-theft indicator is located in the instrument cluster.

- When the ignition is in the off position, the indicator will flash once every two seconds to indicate the SecuriLock™ system is functioning as a theft deterrent.
- When the ignition is in the on position, the indicator will glow for three seconds, then turn off, to indicate normal system functionality.



If a problem occurs with the SecuriLock™ system, the indicator will flash rapidly or glow steadily when the ignition is in the on position. If this occurs, turn the ignition off then back to on to make sure there was no electronic interference with the programmed key. If the vehicle doesn't start, try to start it with the 2nd programmed key and if successful

## Locks and Security

contact your authorized dealership for key replacement. If the indicator still flashes rapidly or glows steadily, and the vehicle will not start, contact your authorized dealer as soon as possible for service.

### Replacement keys

If your keys are lost or stolen and you don't have an extra coded key, you will need to have your vehicle towed to an authorized dealer. The key codes need to be erased from your vehicle and new coded keys will need to be programmed.

Replacing coded keys can be very costly. Store an extra programmed key away from the vehicle in a safe place to help prevent any inconveniences. Please visit an authorized dealer to purchase additional spare or replacement keys.

### Programming spare keys

You can program your own coded keys to your vehicle. Please read and understand the entire procedure before you begin.

#### Tips:

- A maximum of eight keys can be coded to your vehicle.
- Only use SecuriLock™ keys.
- You must have two previously programmed coded keys (keys that already operate your vehicle's engine) and the new unprogrammed key(s) readily accessible.
- If two previously programmed coded keys are not available, you must take your vehicle to your authorized dealer to have the spare key(s) programmed.

1. Insert a previously programmed coded key into the ignition.
2. Turn the ignition from the 1 (off) position to the 3 (on) position. Keep the ignition in the 3 (on) position for at least one second, but no more than 10 seconds.
3. Turn the ignition to the 1 (off) position.
4. Remove the previously programmed coded key from the ignition.
5. Within 10 seconds of removing the previously programmed coded key, insert the other previously programmed coded key into the ignition.

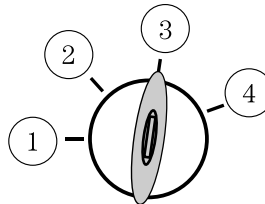

## Locks and Security

6. Turn the ignition from the 1 (off) position to the 3 (on) position. Keep the ignition in the 3 (on) position for at least one second but not more than 10 seconds.
7. Turn the ignition to the 1 (off) position.
8. Remove the previously programmed coded key from the ignition.
9. Within twenty seconds of removing the previously programmed coded key, insert the unprogrammed key (new/valet key) into the ignition.
10. Turn the ignition from the 1 (off) position to the 3 (on) position. Keep the ignition in the 3 (on) position for at least one second, but no more than 10 seconds.
11. Your new, unprogrammed key is now programmed.

If the key has been successfully programmed it will start the vehicle's engine and the theft indicator light will illuminate for three seconds and then go out.

If the key was not successfully programmed, it will not start your vehicle's engine and the theft indicator light will flash on and off, or stay on for more than three seconds. If failure repeats, bring your vehicle to your authorized dealer to have the new key(s) programmed.

To program additional new unprogrammed key(s), repeat this procedure from Step 1 for each additional key.



## Seating and Safety Restraints

### SEATING

**!** **WARNING:** Reclining the seatback can cause an occupant to slide under the seat's safety belt, resulting in severe personal injuries in the event of a collision.

**!** **WARNING:** Do not pile cargo higher than the seatbacks to reduce the risk of injury in a collision or sudden stop.

**!** **WARNING:** Before returning the seatback to its original position, make sure that cargo or any objects are not trapped behind the seatback. After returning the seatback to its original position, pull on the seatback to ensure that it has fully latched. An unlatched seat may become dangerous in the event of a sudden stop or collision.

### Adjustable head restraints

Your vehicle is equipped with front row outboard head restraints that are vertically adjustable.

**!** **WARNING:** To minimize the risk of neck injury in the event of a crash, the driver and passenger occupants should not sit in and/or operate the vehicle, until the head restraint is placed in its proper position. The driver should never adjust the head restraint while the vehicle is in motion.

The adjustable head restraints consist of :

- a trimmed energy absorbing foam and structure (1),
- two steel stems (2),
- a guide sleeve adjust release button (3),
- and a guide sleeve unlock/remove button (4).

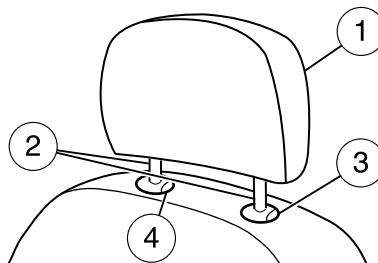

## Seating and Safety Restraints

To adjust the head restraint, do the following:

1. Adjust the seatback to an upright driving/riding position.
2. Raise the head restraint by pulling up on the head restraint.

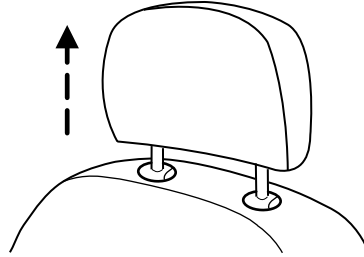

3. Lower the head restraint by pressing and holding the guide sleeve adjust release button and pushing down on the head restraint.

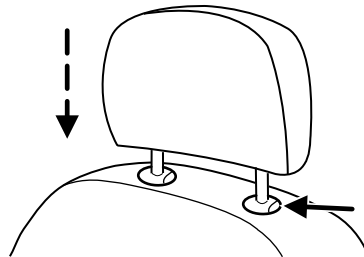

Properly adjust the head restraint so that the top of the head restraint is even with the top of your head and positioned as close as possible to the back of your head. For occupants of extremely tall stature, adjust the head restraint to its full up position.



**WARNING:** The adjustable head restraint is a safety device. Whenever possible it should be installed and properly adjusted when the seat is occupied.

## Seating and Safety Restraints

To remove the adjustable head restraint, do the following:

1. Pull up the head restraint until it reaches the highest adjustment position.

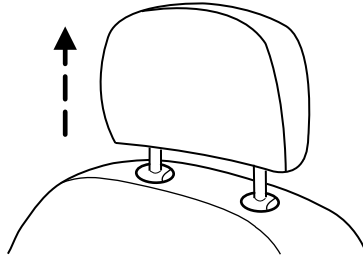

2. Simultaneously press and hold both the adjust/release button and the unlock/remove button, then pull up on the head restraint.

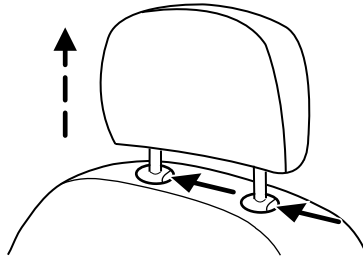

To reinstall the adjustable head restraint, do the following:

1. Insert the two stems into the guide sleeve collars.
2. Push the head restraint down until it locks.

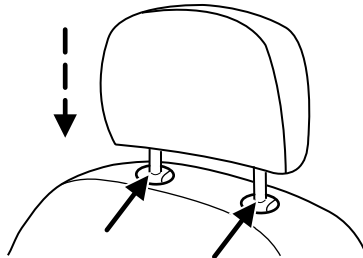

Properly adjust the head restraint so that the top of the head restraint is even with the top of your head and positioned as close as possible to the back of your head. For occupants of extremely tall stature, adjust the head restraint to its full up position.

## Seating and Safety Restraints



**WARNING:** To minimize the risk of neck injury in the event of a crash, head restraints must be installed properly.

### Adjusting the front manual seat



**WARNING:** Sitting improperly out of position or with the seat back reclined too far can take off weight from the seat cushion and affect the decision of the passenger sensing system, resulting in serious injury or death in a crash. Always sit upright against your seatback, with your feet on the floor.



**WARNING:** To reduce the risk of possible serious injury: Do not hang objects off seat back or stow objects in map pocket (if equipped) when a child is in the front passenger seat. Do not place objects underneath the front passenger seat or between the seat and the center console (if equipped). Check the “passenger airbag off” or “pass airbag off” indicator lamp for proper airbag status. Refer to *Front passenger sensing system* chapter for additional details. Failure to follow these instructions may interfere with the front passenger seat sensing system.

Pull the lever located under the front edge of the seat to move the seat forward or backward.

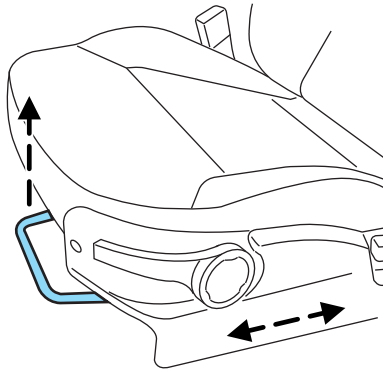

## Seating and Safety Restraints

Pull up on the control to raise the seat and push down on the control to lower the seat.

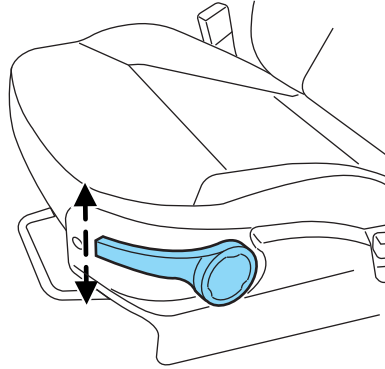

Lift the control to adjust the angle of the seatback.

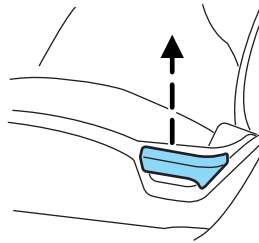

**WARNING:** Reclining the seatback can cause an occupant to slide under the seat's safety belt, resulting in severe personal injuries in the event of a collision.

## Seating and Safety Restraints

### Heated seats (if equipped)

 **WARNING:** Persons who are unable to feel pain to the skin because of advanced age, chronic illness, diabetes, spinal cord injury, medication, alcohol use, exhaustion, or other physical conditions, must exercise care when using the seat heater. The seat heater may cause burns even at low temperatures, especially if used for long periods of time. Do not place anything on the seat that insulates against heat, such as a blanket or cushion, because this may cause the seat heater to overheat. Do not puncture the seat with pins, needles, or other pointed objects because this may damage the heating element which may cause the seat heater to overheat. An overheated seat may cause serious personal injury.

**Note:** Do not do the following:

- Place heavy objects on the seat
- Operate the seat heater if water or any other liquid is spilled on the seat. Allow the seat to dry thoroughly.

To operate the heated seats:

- Push the button located on the instrument panel to activate.
- Push again to deactivate.



The heated seats will activate when the ignition is in the on position and the engine is running.

The system automatically shuts off after 10 minutes.

## Seating and Safety Restraints

### Tip/slide front passenger seat (if equipped)

Lift the control and fold the seatback forward.

The seat can be slid forward to allow easier entry to the rear seats. Slide the seat back and fold back the seatback until it locks with a distinct click. Rock the seat to ensure that the catch is securely engaged.



**WARNING:** Do not place objects behind the seat which could prevent the engagement of the seat lock.

## REAR SEATS

### Rear head restraints

Your vehicle is equipped with rear head restraints that are vertically adjustable.

Raise the head restraint by pulling up on the head restraint.

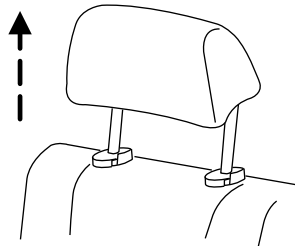

## Seating and Safety Restraints

Lower the head restraint by pressing and holding the guide sleeve release button and pushing down on the head restraint.

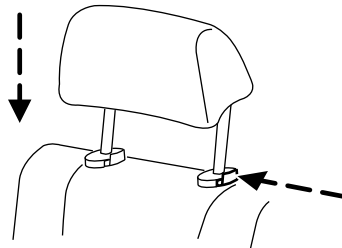

For details about the individual components of the head restraints and about how to remove the head restraints, refer to *Adjustable head restraints* at the beginning of this chapter.

### Folding down the rear seat

One or both rear seatbacks can be folded down to provide additional cargo space.

To lower the seatback(s) from inside the vehicle, do the following:

1. Lower the head restraint (if equipped) to the lowest position.
2. Pull the strap located on the inboard side of the seatback (passenger side) or on the outboard side of the seatback (driver side) to release it.
3. Fold the seatback down.

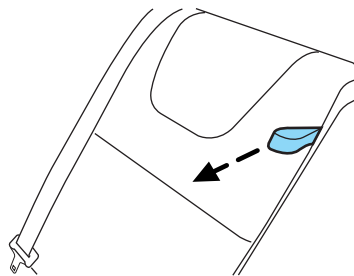

When raising the seatback(s), make sure you hear the seat latch into place.

**!** **WARNING:** Before returning the seatback to its original position, make sure that cargo or any objects are not trapped behind the seatback. After returning the seatback to its original position, pull on the seatback to ensure that it has fully latched. An unlatched seat may become dangerous in the event of a sudden stop or collision.



## Seating and Safety Restraints

### SAFETY RESTRAINTS

#### Personal Safety System®

The Personal Safety System® provides an improved overall level of frontal crash protection to front seat occupants and is designed to help further reduce the risk of airbag-related injuries. The system is able to analyze different occupant conditions and crash severity before activating the appropriate safety devices to help better protect a range of occupants in a variety of frontal crash situations.

Your vehicle's Personal Safety System® consists of:

- Driver and passenger dual-stage airbag supplemental restraints.
- Front safety belts with pretensioners, energy management retractors, and safety belt usage sensors.
- Driver's seat position sensor.
- Front crash severity sensor.
- Front passenger sensing system
- "Passenger airbag off" or "pass airbag off" indicator lamp
- Restraints Control Module (RCM) with impact and safing sensors.
- Restraint system warning light and back-up tone.
- The electrical wiring for the airbags, crash sensor(s), safety belt pretensioners, front safety belt usage sensors, driver seat position sensor, and indicator lights.

#### ***How does the Personal Safety System® work?***

The Personal Safety System® can adapt the deployment strategy of your vehicle's safety devices according to crash severity and conditions. A collection of crash sensors provides information to the Restraints Control Module (RCM). During a crash, the RCM may activate the safety belt pretensioners and/or either none, one, or both stages of the dual-stage airbag supplemental restraints based on crash severity and conditions.

The fact that the pretensioners or airbags did not activate for both front seat occupants in a collision does not mean that something is wrong with the system. Rather, it means the Personal Safety System® determined the accident conditions (crash severity, belt usage, etc.) were not appropriate to activate these safety devices. Front airbags are designed to activate only in frontal and near-frontal collisions, not rollovers, side-impacts, or rear-impacts unless the collision causes sufficient longitudinal deceleration.

## Seating and Safety Restraints

### ***Driver and passenger dual-stage airbag supplemental restraints***

The dual-stage airbags offer the capability to tailor the level of airbag inflation energy. A lower, less forceful energy level is provided for more common, moderate-severity impacts. A higher energy level is used for the most severe impacts. Refer to *Airbag supplemental restraints (SRS)* section in this chapter.

### ***Front crash severity sensor***

The front crash severity sensor enhances the ability to detect the severity of an impact. Positioned up front, it provides valuable information early in the crash event on the severity of the impact. This allows your Personal Safety System® to distinguish between different levels of crash severity and modify the deployment strategy of the dual-stage airbags and safety belt pretensioners.

### ***Driver's seat position sensor***

The driver's seat position sensor allows your Personal Safety System® to tailor the deployment level of the driver dual-stage airbag based on seat position. The system is designed to help protect smaller drivers sitting close to the driver airbag by providing a lower airbag output level.

### ***Front passenger sensing system***

For airbags to do their job they must inflate with great force, and this force can pose a potentially deadly risk to occupants that are very close to the airbag when it begins to inflate. For some occupants, like infants in rear-facing child seats, this occurs because they are initially sitting very close to the airbag. For other occupants, this occurs when the occupant is not properly restrained by safety belts or child safety seats and they move forward during pre-crash braking. The most effective way to reduce the risk of unnecessary injuries is to make sure all occupants are properly restrained. Accident statistics suggest that children are much safer when properly restrained in the rear seating positions than in the front.



**WARNING:** Air bags can kill or injure a child in a child seat. **NEVER** place a rear-facing child seat in front of an active air bag. If you must use a forward-facing child seat in the front seat, move the seat all the way back.



**WARNING:** Always transport children 12 years old and under in the back seat and always properly use appropriate child restraints.

## Seating and Safety Restraints

The front passenger sensing system can automatically turn off the passenger front airbag. The system is designed to help protect small (child size) occupants from airbag deployments when they are improperly seated or restrained in the front passenger seat contrary to proper child-seating or restraint usage recommendations. Even with this technology, parents are **STRONGLY** encouraged to always properly restrain children in the rear seat. The sensor also turns off the airbag when the passenger seat is empty to prevent unnecessary replacement of the airbag(s) after a collision.

When the front passenger seat is occupied and the sensing system has turned off the passenger's frontal airbag, the "pass airbag off" indicator will light and stay lit to remind you that the front passenger frontal airbag is off. See *Front passenger sensing system* in the *Airbag supplemental restraints (SRS)* section of this chapter.

### **Front safety belt usage sensors**

The front safety belt usage sensors detect whether or not the driver and front outboard passenger safety belts are fastened. This information allows your Personal Safety System® to tailor the airbag deployment and safety belt pretensioner activation depending upon safety belt usage.

### **Front outboard safety belt pretensioners**

The safety belt pretensioners at the front outboard seating positions are designed to tighten the safety belts firmly against the occupant's body during frontal collisions, and in side collisions when the side air curtain system activates. This helps increase the effectiveness of the safety belts. In frontal collisions, the safety belt pretensioners can be activated alone or, if the collision is of sufficient severity, together with the front airbags.

### **Front outboard safety belt energy management retractors**

The front safety belt energy management retractors allow webbing to be pulled out of the retractor in a gradual and controlled manner in response to the occupant's forward momentum. This helps reduce the risk of force-related injuries to the occupant's chest by limiting the load on the occupant. Refer to the *Energy management feature* section in this chapter.

### **Determining if the Personal Safety System® is operational**

The Personal Safety System® uses a warning light in the instrument cluster or a back-up tone to indicate the condition of the system. Refer to the *Warning light* section in the *Instrument Cluster* chapter. Routine maintenance of the Personal Safety System® is not required.

## Seating and Safety Restraints

The Restraints Control Module (RCM) monitors its own internal circuits and the circuits for the airbag supplemental restraints, crash sensor(s), safety belt pretensioners, front safety belt buckle sensors, front passenger sensing system, and the driver seat position sensor. In addition, the RCM also monitors the restraints warning light in the instrument cluster. A difficulty with the system is indicated by one or more of the following.

- The warning light will either flash or stay lit.
- The warning light will not illuminate immediately after ignition is turned on.
- A series of five beeps will be heard. The tone pattern will repeat periodically until the problem and warning light are repaired.

If any of these things happen, even intermittently, have the Personal Safety System® serviced at an authorized dealer immediately. Unless serviced, the system may not function properly in the event of a collision.

### Safety belt precautions



**WARNING:** Always drive and ride with your seatback upright and the lap belt snug and low across the hips.



**WARNING:** To reduce the risk of injury, make sure children sit where they can be properly restrained.



**WARNING:** Never let a passenger hold a child on his or her lap while the vehicle is moving. The passenger cannot protect the child from injury in a collision.



**WARNING:** All occupants of the vehicle, including the driver, should always properly wear their safety belts, even when an air bag supplemental restraint system (SRS) is provided.



**WARNING:** It is extremely dangerous to ride in a cargo area, inside or outside of a vehicle. In a collision, people riding in these areas are more likely to be seriously injured or killed. Do not allow people to ride in any area of your vehicle that is not equipped with seats and safety belts. Be sure everyone in your vehicle is in a seat and using a safety belt properly.

## Seating and Safety Restraints



**WARNING:** In a rollover crash, an unbelted person is significantly more likely to die than a person wearing a seat belt.



**WARNING:** Each seating position in your vehicle has a specific safety belt assembly which is made up of one buckle and one tongue that are designed to be used as a pair. 1) Use the shoulder belt on the outside shoulder only. Never wear the shoulder belt under the arm. 2) Never swing the safety belt around your neck over the inside shoulder. 3) Never use a single belt for more than one person.



**WARNING:** When possible, all children 12 years old and under should be properly restrained in a rear seating position.



**WARNING:** Front and rear seat occupants, including pregnant women, should wear safety belts for optimum protection in an accident.

### Combination lap and shoulder belts

1. Insert the belt tongue into the proper buckle (the buckle closest to the direction the tongue is coming from) until you hear a snap and feel it latch. Make sure the tongue is securely fastened in the buckle.

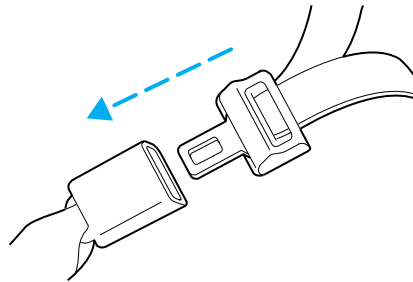

## Seating and Safety Restraints

2. To unfasten, push the release button and remove the tongue from the buckle.

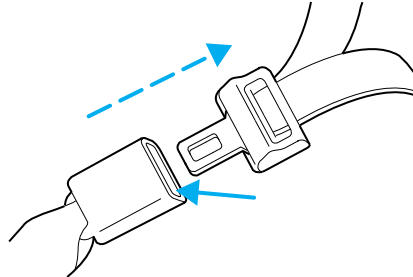

### Energy management feature

- This vehicle has a safety belt system with an energy management feature at the front outboard seating positions to help further reduce the risk of injury in the event of a head-on collision.
- This safety belt system has a retractor assembly that is designed to pay out webbing in a controlled manner. This feature is designed to help reduce the belt force acting on the occupant's chest.

The front outboard and rear safety restraints in the vehicle are combination lap and shoulder belts. The front passenger and rear seat outboard safety belts have two types of locking modes.

### Vehicle sensitive mode

The vehicle sensitive mode is the normal retractor mode, allowing free shoulder belt length adjustment to your movements and locking in response to vehicle movement. For example, if the driver brakes suddenly or turns a corner sharply, or the vehicle receives an impact of approximately 5 mph (8 km/h) or more, the combination safety belts will lock to help reduce forward movement of the driver and passengers.

### Automatic locking mode

#### ***When to use the automatic locking mode***

In this mode, the shoulder belt is automatically pre-locked. The belt will still retract to remove any slack in the shoulder belt. The automatic locking mode is not available on the driver safety belt.

This mode should be used **any time** a child safety seat (except a booster) is installed in a passenger front or outboard rear seating position (if equipped). Children 12 years old and under should be properly restrained in the rear seat whenever possible. Refer to *Safety restraints for children* or *Safety seats for children* later in this chapter.

## Seating and Safety Restraints

### **How to use the automatic locking mode**

- Buckle the combination lap and shoulder belt.

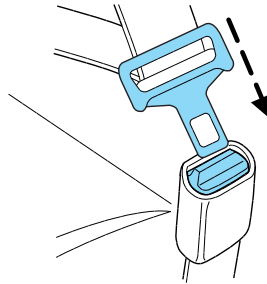

- Grasp the shoulder portion and pull downward until the entire belt is pulled out.



- Allow the belt to retract. As the belt retracts, you will hear a clicking sound. This indicates the safety belt is now in the automatic locking mode.

### **How to disengage the automatic locking mode**



**WARNING:** Ford Motor Company recommends that all passenger safety belt assemblies and attaching hardware should be inspected by an authorized dealer after any collision to verify that the "automatic locking retractor" feature for child seats is still working properly. Safety belt assemblies should be inspected by an authorized dealer and must be replaced if either damage or improper operation is noted. Failure to replace the belt and retractor assembly could increase the risk of injury in a collision.

Unbuckle the combination lap/shoulder belt and allow it to retract completely to disengage the automatic locking mode and activate the vehicle sensitive (emergency) locking mode.

## Seating and Safety Restraints

### Safety belts with locking cinch tongue (rear center position only)

The locking cinch tongue will slide up and down the belt webbing when the belt is in the stowed position or while putting safety belts on. When the locking cinch tongue of the lap/shoulder combination safety belt is latched into the buckle, the cinch tongue will allow the lap portion to become shorter, but locks the webbing in place to restrict it from becoming longer.

Before you can reach and latch a combination lap and shoulder belt having a cinch tongue into the buckle, you may have to lengthen the lap belt portion of it.

1. To lengthen the lap belt, pull some webbing out of the shoulder belt retractor.
2. While holding the webbing below the tongue, grasp the tip (metal portion) of the tongue so that it is parallel to the webbing and slide the tongue upward.

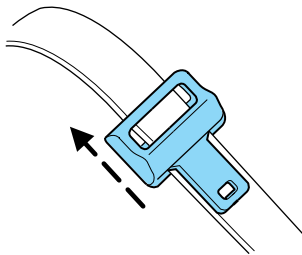

3. Provide enough lap belt length so that the tongue can reach the buckle.

### How to fasten the cinch tongue

1. Pull the combination lap and shoulder belt from the retractor so that the shoulder belt portion of the safety belt crosses your shoulder and chest.
2. Be sure the belt is not twisted. If the belt is twisted, remove the twist.
3. Insert the belt tongue into the proper buckle for your seating position until you hear a snap and feel it latch.
4. Make sure the tongue is securely fastened to the buckle by pulling on the tongue.



**WARNING:** The lap belt should fit snugly and as low as possible around the hips, not across the waist.



**WARNING:** Front and rear seat occupants, including pregnant women, should wear safety belts for optimum protection in an accident.



## Seating and Safety Restraints

**WARNING:** Each seating position in your vehicle has a specific safety belt assembly which is made up of one buckle and one tongue that are designed to be used as a pair. 1) Use the shoulder belt on the outside shoulder only. Never wear the shoulder belt under the arm. 2) Never swing the safety belt around your neck over the inside shoulder. 3) Never use a single belt for more than one person.

While you are fastened in the safety belt, the combination lap/shoulder belt with a cinch tongue adjusts to your movement. However, if you brake hard, turn hard, or if your vehicle receives an impact of 8 km/h (5 mph) or more, the safety belt will become locked and help reduce your forward movement.

### Front safety belt height adjustment

Adjust the height of the shoulder belt so the belt rests across the middle of your shoulder.

To adjust the shoulder belt height, squeeze the buttons and slide the height adjuster up or down. Release the button and pull down on the height adjuster to make sure it is locked in place.

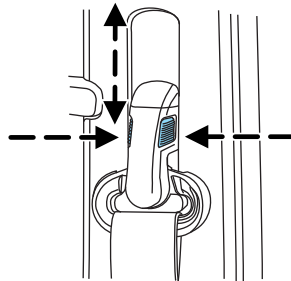

**WARNING:** Position the safety belt height adjusters so that the belt rests across the middle of your shoulder. Failure to adjust the safety belt properly could reduce the effectiveness of the seat belt and increase the risk of injury in a collision.

### Safety belt pretensioner

Your vehicle is equipped with safety belt pretensioners at the driver and front outboard passenger seating positions.

The safety belt pretensioner tightens the safety belts firmly against the occupant's body at the start of the crash.

**WARNING:** The driver and front passenger safety belt system (including retractors, buckles and height adjusters) must be replaced if the vehicle is involved in a collision that results in deployment of front airbags, seat-mounted side airbags and side air curtains, and safety belt pretensioners.

## Seating and Safety Restraints

### Safety belt extension assembly

If the safety belt is too short when fully extended, there is an 8 inch (20 cm) safety belt extension assembly that can be added (part number 611C22). This assembly can be obtained from an authorized dealer.

Use only extensions manufactured by the same supplier as the safety belt. Manufacturer identification is located at the end of the webbing on the label. Also, use the safety belt extension only if the safety belt is too short for you when fully extended.



**WARNING:** Do not use extensions to change the fit of the shoulder belt across the torso.

### Safety belt warning light and indicator chime

The safety belt warning light illuminates in the instrument cluster and a chime sounds to remind the occupants to fasten their safety belts.

#### Conditions of operation

If...	Then...
The driver's safety belt is not buckled before the ignition switch is turned to the on position...	The safety belt warning light illuminates 1-2 minutes and the warning chime sounds 4-8 seconds.
The driver's safety belt is buckled while the indicator light is illuminated and the warning chime is sounding...	The safety belt warning light and warning chime turn off.
The driver's safety belt is buckled before the ignition switch is turned to the on position...	The safety belt warning light and indicator chime remain off.

### Belt-Minder®

The Belt-Minder® feature is a supplemental warning to the safety belt warning function. This feature provides additional reminders by intermittently sounding a chime and illuminating the safety belt warning light in the instrument cluster when the driver's and front passenger's safety belt is unbuckled.

The Belt-Minder® feature uses information from the front passenger sensing system to determine if a front seat passenger is present and

## Seating and Safety Restraints

therefore potentially in need of a warning. To avoid activating the Belt-Minder® feature for objects placed in the front passenger seat, warnings will only be given to large front seat occupants as determined by the front passenger sensing system.

Both the driver's and passenger's safety belt usages are monitored and either may activate the Belt-Minder® feature. The warnings are the same for the driver and the front passenger. If the Belt-Minder® warnings have expired (warnings for approximately five minutes) for one occupant (driver or front passenger), the other occupant can still activate the Belt-Minder® feature.

If...	Then...
The driver's and front passenger's safety belts are buckled before the ignition switch is turned to the on position or less than 1-2 minutes have elapsed since the ignition switch has been turned to on...	The Belt-Minder® feature will not activate.
The driver's or front passenger's safety belt is not buckled when the vehicle has reached at least 3 mph (5 km/h) and 1-2 minutes have elapsed since the ignition switch has been turned to on...	The Belt-Minder® feature is activated - the safety belt warning light illuminates and the warning chime sounds for six seconds every 30 seconds, repeating for approximately five minutes or until the safety belts are buckled.
The driver's or front passenger's safety belt becomes unbuckled for approximately one minute while the vehicle is traveling at least 3 mph (5 km/h) and more than 1-2 minutes have elapsed since the ignition switch has been turned to on...	The Belt-Minder® feature is activated - the safety belt warning light illuminates and the warning chime sounds for six seconds every 30 seconds, repeating for approximately five minutes or until the safety belts are buckled.

## Seating and Safety Restraints

The following are reasons most often given for not wearing safety belts (All statistics based on U.S. data):

Reasons given...	Consider...
"Crashes are rare events"	<b>36700 crashes occur every day.</b> The more we drive, the more we are exposed to "rare" events, even for good drivers. <i>1 in 4 of us will be seriously injured in a crash during our lifetime.</i>
"I'm not going far"	<b>3 of 4</b> fatal crashes occur within <b>25</b> miles (40 km) of home.
"Belts are uncomfortable"	We design our safety belts to enhance comfort. If you are uncomfortable - try different positions for the safety belt upper anchorage and seatback which should be as upright as possible; this can improve comfort.
"I was in a hurry"	<b>Prime time for an accident.</b> Belt-Minder® reminds us to take a few seconds to buckle up.
"Safety belts don't work"	<b>Safety belts</b> , when used properly, <b>reduce risk of death</b> to front seat occupants by <b>45% in cars</b> , and by <b>60% in light trucks</b> .
"Traffic is light"	<b>Nearly 1 of 2 deaths occur in single-vehicle crashes</b> , many when no other vehicles are around.
"Belts wrinkle my clothes"	Possibly, but a serious crash can do much more than wrinkle your clothes, particularly if you are unbelted.
"The people I'm with don't wear belts"	Set the example, teen deaths occur 4 times more often in vehicles with TWO or MORE people. Children and younger brothers/sisters imitate behavior they see.
"I have an airbag"	Airbags offer greater protection when used with safety belts. Frontal airbags are not designed to inflate in rear and side crashes or rollovers.
"I'd rather be thrown clear"	Not a good idea. <b>People</b> who are <b>ejected are 40 times more likely to DIE</b> . Safety belts help prevent ejection, WE CAN'T "PICK OUR CRASH".

## Seating and Safety Restraints



**WARNING:** Do not sit on top of a buckled safety belt or insert a latchplate into the buckle to avoid the Belt-Minder® chime. To do so may adversely affect the performance of the vehicle's air bag system.

### **One-time disable**

If at any time the driver/front passenger quickly buckles then unbuckles the safety belt for that seating position, the Belt-Minder® is disabled for the current ignition cycle. The Belt-Minder® feature will enable during the same ignition cycle if the occupant buckles and remains buckled for approximately 30 seconds. Confirmation is not given for the one time disable.

### **Deactivating/activating the Belt-Minder® feature**

**The driver and front passenger Belt-Minder® are deactivated/activated independently. When deactivating/activating one seating position, do not buckle the other position as this will terminate the process.**

*Read Steps 1 - 4 thoroughly before proceeding with the deactivation/activation programming procedure.*

**Note:** The driver and front passenger Belt-Minder® features must be disabled/enabled separately. Both cannot be disabled/enabled during the same key cycle.

The driver and front passenger Belt-Minder® features can be deactivated/activated by performing the following procedure:

Before following the procedure, make sure that:

- The parking brake is set
- The gearshift is in P (Park) (automatic transmission) and in neutral (manual transmission)
- The ignition switch is in the off position
- The driver and front passenger safety belts are unbuckled



**WARNING:** While the design allows you to deactivate your Belt-Minder®, this system is designed to improve your chances of being safely belted and surviving an accident. We recommend you leave the Belt-Minder® system activated for yourself and others who may use the vehicle. To reduce the risk of injury, do not deactivate/activate the Belt-Minder® feature while driving the vehicle.

## Seating and Safety Restraints

1. Turn the ignition switch to the on position. **DO NOT START THE ENGINE.**
2. Wait until the safety belt warning light turns off (Approximately one minute).
  - Step 3 must be completed within 50 seconds after the safety belt warning light turns off.
3. For the seating position being disabled, at a moderate speed, buckle then unbuckle the safety belt nine times, ending in the unbuckled state. Step 3 must be completed within 50 seconds after the safety belt warning light turns off.
  - After Step 3, the safety belt warning light will be turned on for three seconds.
4. Within approximately seven seconds of the light turning off, buckle then unbuckle the safety belt.
  - This will disable the Belt-Minder® feature for that seating position if it is currently enabled. As confirmation, the safety belt warning light will flash one time per second for three seconds.
  - This will enable the Belt-Minder® feature for that seating position if it is currently disabled. As confirmation, the safety belt warning light will flash four times per second for three seconds, followed by three seconds with the light off, then followed by the safety belt warning light flashing one time per second for three seconds again.

### AIRBAG SUPPLEMENTAL RESTRAINT SYSTEM (SRS)

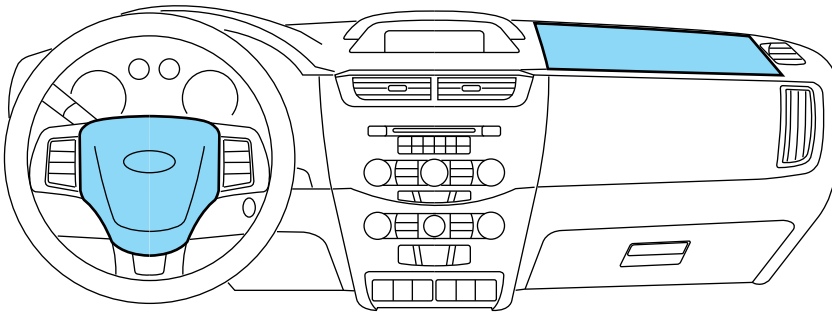

The supplemental restraint system is designed to work with the safety belt to help protect the driver and right front passenger from certain upper body injuries.

## Seating and Safety Restraints

 **WARNING:** Airbags **DO NOT** inflate slowly or gently, and the risk of injury from a deploying airbag is the greatest close to the trim covering the airbag module.

### Important SRS precautions

The SRS is designed to work with the safety belt to help protect the driver and right front passenger from certain upper body injuries. Airbags **DO NOT** inflate slowly; there is a risk of injury from a deploying airbag.

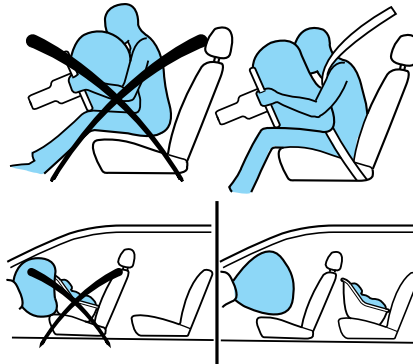

 **WARNING:** All occupants of the vehicle, including the driver, should always properly wear their safety belts, even when an air bag supplemental restraint system (SRS) is provided.

 **WARNING:** When possible, all children 12 years old and under should be properly restrained in a rear seating position.

 **WARNING:** The National Highway Traffic Safety Administration (NHTSA) recommends a minimum distance of at least 10 inches (25 cm) between an occupant's chest and the driver airbag module.

 **WARNING:** Never place your arm over the airbag module as a deploying airbag can result in serious arm fractures or other injuries.

## Seating and Safety Restraints

To properly position yourself away from the airbag:

- Move your seat to the rear as far as you can while still reaching the pedals comfortably.
- Recline the seat slightly one or two degrees from the upright position.

 **WARNING:** Do not put anything on or over the airbag module. Placing objects on or over the airbag inflation area may cause those objects to be propelled by the airbag into your face and torso causing serious injury.

 **WARNING:** Do not attempt to service, repair, or modify the airbag supplemental restraint systems or its fuses. Contact your authorized dealer as soon as possible.

### Children and airbags

Children must always be properly restrained. Accident statistics suggest that children are safer when properly restrained in the rear seating positions than in the front seating position. Failure to follow these instructions may increase the risk of injury in a collision.

 **WARNING:** Airbags can kill or injure a child in a child seat. **NEVER** place a rear-facing child seat in front of an active airbag. If you must use a forward-facing child seat in the front seat, move the seat all the way back.

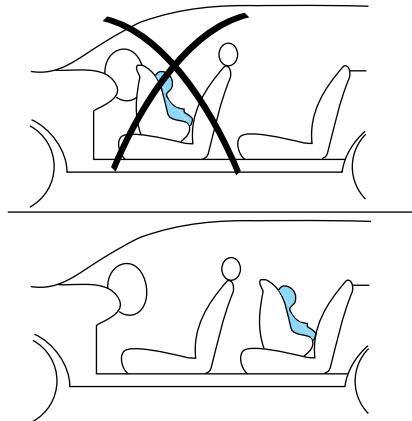



## Seating and Safety Restraints

### How does the airbag supplemental restraint system work?

The airbag SRS is designed to activate when the vehicle sustains longitudinal deceleration sufficient to cause the sensors to close an electrical circuit that initiates airbag inflation. The fact that the airbags did not inflate in a collision does not mean that something is wrong with the system. Rather, it means the forces were not of the type sufficient to cause activation. Front airbags are designed to inflate in frontal and near-frontal collisions, not rollover, side-impact, or rear-impacts unless the collision causes sufficient longitudinal deceleration.

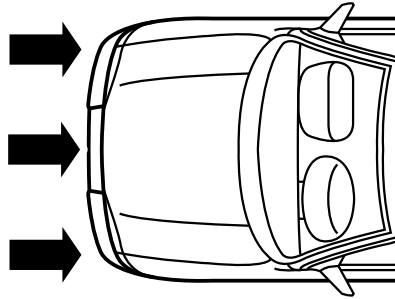

The airbags inflate and deflate rapidly upon activation. After airbag deployment, it is normal to notice a smoke-like, powdery residue or smell the burnt propellant. This may consist of cornstarch, talcum powder (to lubricate the bag) or sodium compounds (e.g., baking soda) that result from the combustion process that inflates the airbag. Small amounts of sodium hydroxide may be present which may irritate the skin and eyes, but none of the residue is toxic.



While the system is designed to help reduce serious injuries, contact with a deploying airbag may also cause abrasions, swelling or temporary hearing loss. Because airbags must inflate rapidly and with considerable force, there is the risk of death or serious injuries such as fractures, facial and eye injuries or internal injuries, particularly to occupants who are not properly restrained or are otherwise out of position at the time of airbag deployment. Thus, it is extremely important that occupants be properly restrained as far away from the airbag module as possible while maintaining vehicle control.

## Seating and Safety Restraints



**WARNING:** Several air bag system components get hot after inflation. Do not touch them after inflation.



**WARNING:** If the air bag has deployed, **the air bag will not function again and must be replaced immediately.** If the air bag is not replaced, the unrepaired area will increase the risk of injury in a collision.

The SRS consists of:

- driver and passenger airbag modules (which include the inflators and airbags).
- side airbags. Refer to *Seat-mounted side airbag system* later in this chapter.
- side air curtain system. Refer to *Side air curtain system* later in this chapter.
- safety belt pretensioners
- one or more impact and safing sensors.
- Front passenger sensing system. Refer to *Front passenger sensing system* later in this chapter.
- “Passenger airbag off” or “pass airbag off” indicator lamp. Refer to *Front passenger sensing system* later in this chapter.
- a readiness light and tone.
- diagnostic module.
- and the electrical wiring which connects the components.

The diagnostic module monitors its own internal circuits and the supplemental airbag electrical system wiring (including the impact sensors), the system wiring, the airbag system readiness light, the airbag back up power and the airbag ignitors.

### Front passenger sensing system

The front passenger sensing system is designed to meet the regulatory requirements of Federal Motor Vehicle Safety Standard (FMVSS) 208 and is designed to disable (will not inflate) the front passenger’s frontal airbag under certain conditions.

The front passenger sensing system works with sensors that are part of the front passenger’s seat and safety belt. The sensors are designed to

## Seating and Safety Restraints

detect the presence of a properly seated occupant and determine if the front passenger's frontal airbag should be enabled (may inflate) or disabled (will not inflate).

The front passenger sensing system will disable (will not inflate) the front passenger's frontal airbag if:

- the front passenger seat is unoccupied, or has small/medium objects in the front seat,
- the system determines that an infant is present in a rear-facing infant seat that is installed according to the manufacturer's instructions,
- the system determines that a small child is present in a forward-facing child restraint that is installed according to the manufacturer's instructions,
- the system determines that a small child is present in a booster seat,
- a front passenger takes his/her weight off of the seat for a period of time,
- a child or a small person occupies the front passenger seat.

The front passenger sensing system will turn off the passenger seat side airbag if:

- the seat is empty and safety belt is unbuckled.

The front passenger sensing system uses a "passenger airbag off" or "pass airbag off" indicator which will illuminate and stay lit to remind you that the front passenger frontal airbag is disabled. The indicator lamp is located at the top of the instrument panel center stack area below the Hazard warning indicator and above the radio.



**Note:** The indicator lamp will illuminate for a short period of time when the ignition is turned to the on position to confirm it is functional.

When the front passenger seat is not occupied (empty seat) or in the event that the front passenger frontal airbag is enabled (may inflate), the indicator lamp will be unlit.

The front passenger sensing system is designed to disable (will not inflate) the front passenger's frontal airbag when a rear facing infant seat, a forward-facing child restraint, or a booster seat is detected.

- When the front passenger sensing system disables (will not inflate) the front passenger frontal airbag, the indicator lamp will illuminate and stay lit to remind you that the front passenger frontal airbag is disabled.

## Seating and Safety Restraints

- If the child restraint has been installed and the indicator lamp is not lit, then turn the vehicle off, remove the child restraint from the vehicle and reinstall the restraint following the child restraint manufacturer's instructions.

The front passenger sensing system is designed to enable (may inflate) the front passenger's frontal airbag anytime the system senses that a person of adult size is sitting properly in the front passenger seat.

- When the front passenger sensing system enables the front passenger frontal airbag (may inflate), the indicator will be unlit and stay unlit.

If a person of adult size is sitting in the front passenger's seat, but the "passenger airbag off" or "pass airbag off" indicator lamp is lit, it is possible that the person isn't sitting properly in the seat. If this happens:

- Turn the vehicle off and ask the person to place the seatback in the full upright position.
- Have the person sit upright in the seat, centered on the seat cushion, with the person's legs comfortably extended.
- Restart the vehicle and have the person remain in this position for about two minutes. This will allow the system to detect that person and enable the passenger's frontal airbag.
- If the indicator lamp remains lit even after this, the person should be advised to ride in the rear seat.

Occupant	Pass Airbag Off Indicator Lamp	Passenger Airbag
Empty seat	Unlit	Disabled
Small child in child safety seat or booster	Lit	Disabled
Small child with safety belt buckled or unbuckled	Lit	Disabled
Adult	Unlit	Enabled



**WARNING:** Even with Advanced Restraints Systems, children 12 and under should be properly restrained in a rear seating position.

After all occupants have adjusted their seats and put on safety belts, it's very important that they continue to sit properly. A properly seated occupant sits upright, leaning against the seat back, and centered on the

## Seating and Safety Restraints

seat cushion, with their feet comfortably extended on the floor. Sitting improperly can increase the chance of injury in a crash event. For example, if an occupant slouches, lies down, turns sideways, sits forward, leans forward or sideways, or puts one or both feet up, the chance of injury during a crash is greatly increased.



**WARNING:** Sitting improperly out of position or with the seat back reclined too far can take off weight from the seat cushion and affect the decision of the front passenger sensing system, resulting in serious injury or death in a crash. Always sit upright against your seatback, with your feet on the floor.

The front passenger sensing system may detect small or medium objects placed on the seat cushion. For most objects that are in the front passenger seat, the passenger airbag will be disabled. Even though the passenger airbag is disabled, the "pass airbag off" lamp may or may not be illuminated according to the table below.

Objects	Pass Airbag Off Indicator Lamp	Passenger Airbag
Small (i.e. three-ring binder, small purse, bottled water)	Unlit	Disabled
Medium (i.e. heavy briefcase, fully packed luggage)	Lit	Disabled
Empty seat, or small to medium object with safety belt buckled	Lit	Disabled

If you think that the status of the passenger airbag off indicator lamp is incorrect, check for the following:

- Objects lodged underneath the seat
- Objects between the seat cushion and the center console (if equipped)
- Objects hanging off the seat back
- Objects stowed in the seatback map pocket (if equipped)
- Objects placed on the occupant's lap
- Cargo interference with the seat
- Other passengers pushing or pulling on the seat
- Rear passenger feet and knees resting or pushing on the seat

## Seating and Safety Restraints

The conditions listed above may cause the weight of a properly seated occupant to be incorrectly interpreted by the passenger sensing system. The person in the front passenger seat may appear heavier or lighter due to the conditions described in the list above.



**WARNING:** To reduce the risk of possible serious injury:

Do not stow objects in seat back map pocket (if equipped) or hang objects off seat back if a child is in the front passenger seat. Do not place objects underneath the front passenger seat or between the seat and the center console (if equipped). Check the “passenger airbag off” or “pass airbag off” indicator lamp for proper airbag Status. Failure to follow these instructions may interfere with the passenger seat sensing system.

In case there is a problem with the front passenger sensing system, the airbag readiness lamp in the instrument cluster will stay lit.



### **If the airbag readiness lamp is lit, do the following:**

The driver and/or adult passengers should check for any objects that may be lodged underneath the front passenger seat or cargo interfering with the seat.

If objects are lodged and/or cargo is interfering with the seat; please take the following steps to remove the obstruction:

- Pull the vehicle over.
- Turn the vehicle off.
- Driver and/or adult passengers should check for any objects lodged underneath the front passenger seat or cargo interfering with the seat.
- Remove the obstruction(s) (if found).
- Restart the vehicle.
- Wait at least two minutes and verify that the airbag readiness lamp is no longer illuminated
- If the airbag readiness lamp remains illuminated, this may or may/not be a problem due to the front passenger sensing system.

DO NOT attempt to repair or service the system; take your vehicle immediately to an authorized dealer.

If it is necessary to modify an advanced front airbag system to accommodate a person with disabilities, contact the Ford Customer

## Seating and Safety Restraints

Relationship Center at the phone number shown in the *Customer Assistance* section of this *Owner's Guide*.



**WARNING:** Any alteration/modification to the front passenger seat may affect the performance of the front passenger sensing system.

### ***Determining if the system is operational***

The supplemental restraint system uses a warning indicator light in the instrument cluster or a back-up tone to indicate the condition of the system. Refer to the *Warning lights and chimes* section in the *Instrument Cluster* chapter. Routine maintenance of the airbag is not required.

A difficulty with the system is indicated by one or more of the following:

- The readiness light (same light for front and side airbag system) will either flash or stay lit.
- The readiness light will not illuminate immediately after ignition is turned on.
- A series of five beeps will be heard. The tone pattern will repeat periodically until the problem and/or light are repaired.



If any of these things happen, even intermittently, have the supplemental restraint system serviced at an authorized dealer immediately. Unless serviced, the system may not function properly in the event of a collision.

### **Seat-mounted side airbag system**



**WARNING:** Do not place objects or mount equipment on or near the airbag cover on the side of the seatbacks of the front seats or in front seat areas that may come into contact with a deploying airbag. Failure to follow these instructions may increase the risk of personal injury in the event of a collision.



**WARNING:** Do not use accessory seat covers. The use of accessory seat covers may prevent the deployment of the side airbags and increase the risk of injury in an accident.

## Seating and Safety Restraints



**WARNING:** Do not lean your head on the door. The side airbag could injure you as it deploys from the side of the seatback.



**WARNING:** Do not attempt to service, repair, or modify the airbag SRS, its fuses or the seat cover on a seat containing an airbag. Contact your authorized dealer as soon as possible.



**WARNING:** All occupants of the vehicle should always wear their safety belts even when an airbag SRS is provided.

### **How does the side airbag system work?**

The design and development of the side airbag system included recommended testing procedures that were developed by a group of automotive safety experts known as the Side Airbag Technical Working Group. These recommended testing procedures help reduce the risk of injuries related to the deployment of side airbags.

The side airbag system consists of the following:

- An inflatable nylon bag (airbag) with a gas generator concealed behind the outboard bolster of the driver and front passenger seatbacks.
- A special seat cover designed to allow airbag deployment.
- The same warning light, electronic control and diagnostic unit as used for the front airbags.
- Two pressure sensors located in the front doors.
- Two crash sensors located between the “B” and “C” pillars.

Side airbags, in combination with safety belts, can help reduce the risk of severe injuries in the event of a significant side impact collision.

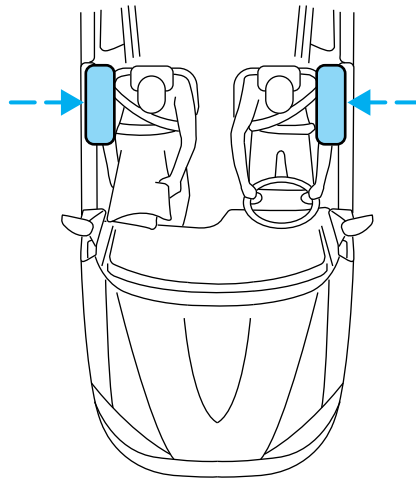



## Seating and Safety Restraints

The side airbags are fitted on the outboard side of the seatbacks of the front seats. In certain lateral collisions, the airbag on the side affected by the collision will be inflated. The front passenger sensing system will turn off the passenger seat side airbag if the seat is empty (unless for some reason the safety belt is properly buckled). The airbag was designed to inflate between the door panel and occupant to further enhance the protection provided occupants in side impact collisions.

The airbag SRS is designed to activate when the vehicle sustains lateral deceleration sufficient to cause the sensors to close an electrical circuit that initiates airbag inflation.

The fact that the airbags did not inflate in a collision does not mean that something is wrong with the system. Rather, it means the forces were not of the type sufficient to cause activation. Side airbags are designed to inflate in side-impact collisions, not roll-over, rear-impact, frontal or near-frontal collisions, unless the collision causes sufficient lateral deceleration.



**WARNING:** Several air bag system components get hot after inflation. Do not touch them after inflation.



**WARNING:** If the side airbag has deployed, **the airbag will not function again. The side airbag system (including the seat) must be inspected and serviced by an authorized dealer.** If the airbag is not replaced, the unrepaired area will increase the risk of injury in a collision.

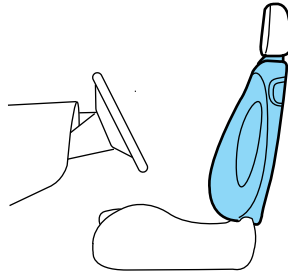



## Seating and Safety Restraints

### Side curtain airbag system

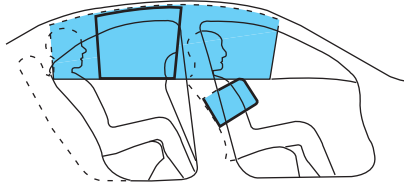
 **WARNING:** Do not place objects or mount equipment on or near the headliner at the siderail that may come into contact with a deploying side air curtain. Failure to follow these instructions may increase the risk of personal injury in the event of a collision.



 **WARNING:** Do not place objects or mount equipment on or near the side air curtain cover.

 **WARNING:** Do not lean your head on the door. The side airbag could injure you as it deploys from the seat.

 **WARNING:** Do not attempt to service, repair, or modify the side air curtain system, its fuses, the A, B, or C pillar trim, or the headliner on a vehicle containing a side air curtain. See your authorized dealer.

 **WARNING:** All occupants of the vehicle, including the driver, should always wear their safety belts even when an inflatable curtain is provided.

 **WARNING:** To reduce the risk of injury, do not obstruct or place objects in the deployment zone of the inflatable curtain.

## Seating and Safety Restraints

### **How does the side air curtain system work?**

The design and development of the side air curtain system included recommended testing procedures that were developed by a group of automotive safety experts known as the Side Airbag Technical Working Group. These recommended testing procedures help reduce the risk of injuries related to the deployment of side airbags (including side air curtain systems).

The side air curtain system consists of the following:

- An inflatable nylon curtain with a gas generator concealed behind the headliner and above the doors.
- The headliner will flex to open above the side doors to allow air curtain deployment.
- The same warning light, electronic control and diagnostic unit as used for the front airbags.
- Two pressure sensors located in the front doors.
- Two crash sensors located on the rocker panel between the “B” and “C” pillars near the floor.

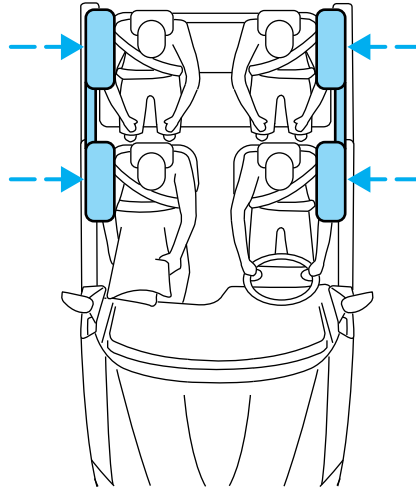

Side air curtains and side airbags, in combination with safety belts, can help reduce the risk of severe injuries in the event of a significant side impact collision.

Children 12 years old and under should always be properly restrained in the rear seats. The side air curtain will not interfere with children restrained using a properly installed child or booster seat because it is designed to inflate downward from the headliner above the doors along the side window openings.

The side air curtains are mounted to the sheet metal above the first and second row seats. In certain lateral collisions, the air curtain and seat-mounted side airbag on the side affected by the collision will be inflated, except that the passenger sensing system will deactivate the passenger seat-mounted side airbag if it detects an empty unbuckled passenger seat. The air curtain was designed to inflate between the side

## Seating and Safety Restraints

window area and occupant to further enhance the head protection provided to occupants in side impact collisions. The seat-mounted side airbag was designed to inflate between the door panel and occupant to further enhance the protection provided occupants in side impact collisions.

The side air curtain system SRS is designed to activate when the vehicle sustains lateral deceleration sufficient to cause the sensors to close an electrical circuit that initiates air curtain and seat-mounted side airbag inflation.

The fact that the side air curtain and seat-mounted side airbag did not inflate in a collision does not mean that something is wrong with the system. Rather, it means the forces were not of the type sufficient to cause activation. The side air curtain system is designed to inflate in side impact collisions, not roll-over, rear impact, frontal or near-frontal collisions, unless the collision causes sufficient lateral deceleration.



**WARNING:** Several air bag system components get hot after inflation. Do not touch them after inflation.



**WARNING:** If the side air curtain has deployed, **the air curtain will not function again. The side air curtain system (including the A, B and C pillar trim and headliner) must be inspected and serviced by an authorized dealer.** If the air curtain is not replaced, the unrepaired area will increase the risk of injury in a collision.

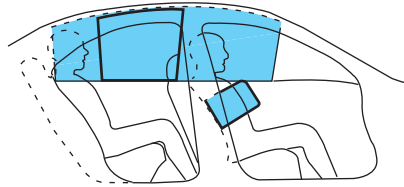

### ***Determining if the system is operational***

The SRS uses a readiness light in the instrument cluster or a tone to indicate the condition of the system. Refer to the *Airbag readiness* section in the *Instrument Cluster* chapter. Routine maintenance of the side airbag is not required.

A difficulty with the system is indicated by one or more of the following:

- The readiness light (same light as for front airbag system) will either flash or stay lit.

## Seating and Safety Restraints

- The readiness light will not illuminate immediately after ignition is turned on.
- A series of five beeps will be heard. The tone pattern will repeat periodically until the problem and/or light are repaired.

If any of these things happen, even intermittently, have the SRS serviced at your authorized dealer immediately. Unless serviced, the system may not function properly in the event of a collision.

### **S.O.S. Post Crash Alert**

The S.O.S Post Crash Alert automatically flashes the turn signal lamps and sounds the horn three times at four second intervals in the event of a serious impact that deploys an airbag (front, side, side curtain or Safety Canopy®) or the safety belt pretensioners.

The S.O.S. Post Crash Alert can be turned off when any one of the following actions are taken by the driver or any other person:

- pressing the hazard control button,
- or pressing the panic button on the remote entry transmitter.

The feature will continue to operate until the vehicle runs out of power.

### **Disposal of airbags and airbag equipped vehicles (including pretensioners)**

Contact your authorized dealer as soon as possible. Airbags MUST BE disposed of by qualified personnel.

## Seating and Safety Restraints

### SAFETY RESTRAINTS FOR CHILDREN

See the following sections for directions on how to properly use safety restraints for children. Also see *Airbag supplemental restraint system (SRS)* in this chapter for special instructions about using airbags.

#### Important child restraint precautions



**WARNING:** Always make sure your child is secured properly in a device that is appropriate for their height, age and weight. Child safety restraints must be purchased separately from the vehicle. Failure to follow these instructions and guidelines may result in an increased risk of serious injury or death to your child.



**WARNING:** All children are shaped differently. The Recommendations for Safety Restraints are based on probable child height, age and weight thresholds from NHTSA and other safety organizations or are the minimum requirements of law. Ford recommends checking with a NHTSA Certified Child Passenger Safety Technician (CPST) and your pediatrician to make sure your child seat is appropriate for your child, and is compatible with and properly installed in the vehicle. To locate a child seat fitting station and CPST contact the NHTSA toll free at 1-888-327-4236 or on the internet at <http://www.nhtsa.dot.gov>. Failure to properly restrain children in safety seats made especially for their height, age, and weight may result in an increased risk of serious injury or death to your child.

## Seating and Safety Restraints

<b>Recommendations for Safety Restraints for Children</b>		
	<b>Child size, height, weight, or age</b>	<b>Recommended re-straint type</b>
Infants or toddlers	Children weighing 40 lb (18 kg) or less (generally age four or younger)	Use a child safety seat (sometimes called an infant carrier, convertible seat, or toddler seat).
Small children	Children who have outgrown or no longer properly fit in a child safety seat (generally children who are less than 4 feet 9 inches (1.45 meters) tall, are greater than age four (4) and less than age twelve (12), and between 40 lbs (18 kg) and 80 lbs (36 kg) and upward to 100 lbs (45 kg) if recommended by your child restraint manufacturer)	Use a belt-positioning booster seat.
Larger children	Children who have outgrown or no longer properly fit in a belt-positioning booster seat (generally children who are at least 4 feet 9 inches (1.45 meters) tall or greater than 80 lb (36 kg) or 100 lb (45 kg) if recommended by child restraint manufacturer)	Use a vehicle safety belt having the lap belt snug and low across the hips, shoulder belt centered across the shoulder and chest, and seatback upright.

- You are required by law to properly use safety seats for infants and toddlers in the U.S. and Canada.
- Many states and provinces require that small children use approved booster seats until they reach age eight, a height of 4 ft 9 in (1.45 meters) tall, or 80 lb (36 kg). Check your local and state or provincial laws for specific requirements regarding the safety of children in your vehicle.
- When possible, always properly restrain children twelve (12) years of age and under in a rear seating position of your vehicle. Accident statistics suggest that children are safer when properly restrained in the rear seating positions than in a front seating position.

## Seating and Safety Restraints

### Recommendations for attaching child safety restraints for children

Re-straint Type	Child Weight	Use any attachment method as indicated below by "X"				
		LATCH (lower anchors and top tether anchor)	LATCH (lower anchors only)	Safety belt and top tether anchor	Safety belt and LATCH (lower anchors and top tether anchor)	Safety belt only
Rear facing child seat	Up to 48 lb (21 kg)		X			X
Forward facing child seat	Up to 48 lb (21 kg)	X		X	X	
Forward facing child seat	Over 48 lb (21 kg)			X	X	



**WARNING:** Air bags can kill or injure a child in a child seat. NEVER place a rear-facing child seat in front of an active air bag. If you must use a forward-facing child seat in the front seat, move the vehicle seat all the way back. When possible, all children age 12 and under should be properly restrained in a rear seating position. If all children cannot be seated and restrained properly in a rear seating position, properly restrain the largest child in the front seat.



## Seating and Safety Restraints



**WARNING:** Always carefully follow the instructions and warnings provided by the manufacturer of any child restraint to determine if the restraint device is appropriate for your child's size, height, weight, or age. Follow the child restraint manufacturer's instructions and warnings provided for installation and use in conjunction with the instructions and warnings provided by the vehicle manufacturer. A safety seat that is improperly installed or utilized, is inappropriate for your child's height, age, or weight or does not properly fit the child may increase the risk of serious injury or death.



**WARNING:** Never let a passenger hold a child on his or her lap while the vehicle is moving. The passenger cannot protect the child from injury in a collision, which may result in serious injury or death.



**WARNING:** Never use pillows, books, or towels to boost a child. They can slide around and increase the likelihood of injury or death in a collision.



**WARNING:** Always restrain an unoccupied child seat or booster seat. These objects may become projectiles in a collision or sudden stop, which may increase the risk of serious injury.



**WARNING:** Never place, or allow a child to place, the shoulder belt under a child's arm or behind the back because it reduces the protection for the upper part of the body and may increase the risk of injury or death in a collision.



**WARNING:** Do not leave children, unreliable adults, or pets unattended in your vehicle.

## Seating and Safety Restraints

### Transporting children

Always make sure your child is secured properly in a device that is appropriate for their age, height and weight. All children are shaped differently. The child height, age and weight thresholds provided are recommendations or the minimum requirements of law. The National Highway Traffic Safety Administration (NHTSA) provides education and training to ensure that all children ages 0 to 16 are properly restrained in the correct restraint system. Ford recommends checking with a NHTSA Certified Child Passenger Safety Technician (CPST) and your pediatrician to make sure your seat is appropriate for your child and properly installed in the vehicle. To locate a child seat fitting station and CPST contact the NHTSA toll free at **1-888-327-4236** or on the internet at <http://www.nhtsa.dot.gov>.

Follow all the safety restraint and airbag precautions that apply to adult passengers in your vehicle.

If the child is the proper height, age, and weight (as specified by your child safety seat or booster manufacturer), fits the restraint and can be restrained properly, then restrain the child in the child safety seat or with the belt-positioning booster. Remember that child seats and belt-positioning boosters vary and may be designed to fit children of different heights, ages and weights. Children who are too large for child safety seats or belt-positioning boosters (as specified by your child safety seat manufacturer) should always properly wear safety belts.

## Seating and Safety Restraints

### SAFETY SEATS FOR CHILDREN

#### Infant and/or toddler seats

Use a safety seat that is recommended for the size and weight of the child.

When installing a child safety seat:

- Review and follow the information presented in the *Airbag supplemental restraint system (SRS)* section in this chapter.
- Carefully follow all of the manufacturer's instructions included with the safety seat you put in your vehicle. If you do not install and use the safety seat properly, the child may be injured in a sudden stop or collision.

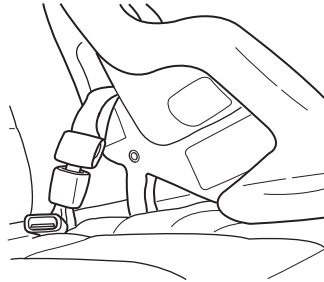

Airbags can kill or injure a child in a child seat. NEVER place a rear-facing child seat in front of an active airbag. If you must use a forward-facing child seat in the front seat, move the vehicle seat all the way back.

Children 12 and under should be properly restrained in a rear seating position whenever possible. If all children cannot be seated and restrained properly in a rear seating position, properly restrain the largest child in the front seat.

#### Installing child safety seats with combination lap and shoulder belts

Check to make sure the child seat is properly secured before each use. Children 12 and under should be properly restrained in a rear seating position whenever possible. If all children cannot be seated and restrained properly in a rear seating position, properly restrain the largest child in the front seat.

When installing a child safety seat with combination lap/shoulder belts:

- Use the correct safety belt buckle for that seating position.
- Insert the belt tongue into the proper buckle until you hear a snap and feel it latch. Make sure the tongue is securely fastened in the buckle.
- Keep the buckle release button pointing up and away from the safety seat, with the tongue between the child seat and the release button, to prevent accidental unbuckling.

## Seating and Safety Restraints

- Place vehicle seat back in upright position.
- Put the safety belt in the automatic locking mode. Refer to Step 5 below.

 **WARNING:** Depending on where you secure a child restraint, and depending on the child restraint design, you may block access to certain safety belt buckle assemblies and/or LATCH lower anchors, rendering those features potentially unusable. To avoid risk of injury, occupants should only use seating positions where they are able to be properly restrained.

Perform the following steps when installing the child seat with combination lap/shoulder belts:

**Note:** Although the child seat illustrated is a forward facing child seat, the steps are the same for installing a rear facing child seat.

1. Position the child safety seat in a seat with a combination lap and shoulder belt.

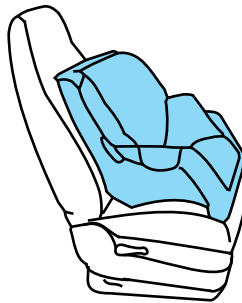

2. Pull down on the shoulder belt and then grasp the shoulder belt and lap belt together.

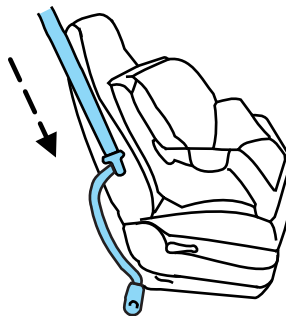

## Seating and Safety Restraints

3. While holding the shoulder and lap belt portions together, route the tongue through the child seat according to the child seat manufacturer's instructions. Be sure the belt webbing is not twisted.

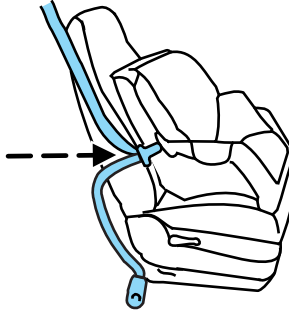

4. Insert the belt tongue into the proper buckle (the buckle closest to the direction the tongue is coming from) for that seating position until you hear a snap and feel the latch engage. Make sure the tongue is latched securely by pulling on it.

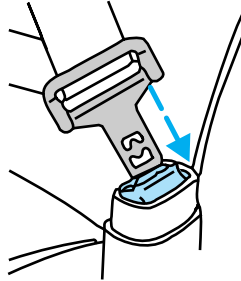

5. To put the retractor in the automatic locking mode, grasp the shoulder portion of the belt and pull downward until all of the belt is pulled out.

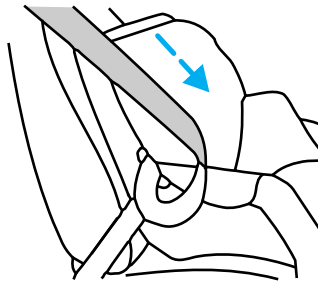

**Note:** The automatic locking mode is available on the front passenger and rear outboard seats only. The rear center seating position has a cinch tongue. Refer to *Installing child safety seats in cinch tongue combination lap shoulder belt seating positions (rear center position only)* in this chapter.

6. Allow the belt to retract to remove slack. The belt will click as it retracts to indicate it is in the automatic locking mode.

## Seating and Safety Restraints

7. Try to pull the belt out of the retractor to make sure the retractor is in the automatic locking mode (you should not be able to pull more belt out). If the retractor is not locked, unbuckle the belt and repeat Steps 5 and 6.

8. Remove remaining slack from the belt. Force the seat down with extra weight, e.g., by pressing down or kneeling on the child restraint while pulling up on the shoulder belt in order to force slack from the belt. This is necessary to remove the remaining slack that will exist once the additional weight of the child is added to the child restraint. It also helps to achieve the proper snugness of the child seat to the vehicle. Sometimes, a slight lean towards the buckle will additionally help to remove remaining slack from the belt.

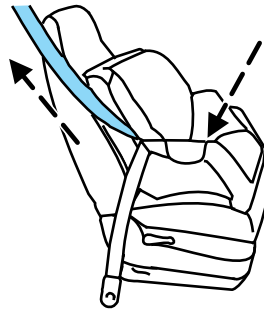

9. Attach the tether strap (if the child seat is equipped). Refer to *Attaching child safety seats with tether straps* later in this chapter.

10. Before placing the child in the seat, forcibly move the seat forward and back to make sure the seat is securely held in place. To check this, grab the seat at the belt path and attempt to move it side to side and forward and back. There should be no more than one inch (2.5 cm) of movement for proper installation.

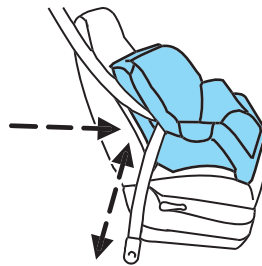

11. Ford recommends checking with a NHTSA Certified Child Passenger Safety Technician (CPST) to make certain the child restraint is properly installed.

## Seating and Safety Restraints

### **Installing child safety seats in cinch tongue combination lap and shoulder belt seating positions (rear center position only)**

The belt webbing below the tongue is the lap portion of the combination lap/shoulder belt, and the belt webbing above the tongue is the shoulder belt portion of the combination lap/shoulder belt.

**Note:** Although the child seat illustrated is a forward facing child seat, the steps are the same for installing a rear facing child seat.

1. Position the child safety seat in a seat with a combination lap and shoulder belt.

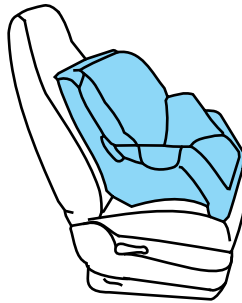

**WARNING:** Airbags can kill or injure a child in a child seat. If you must use a forward-facing child seat in the front seat, move seat all the way back.



**WARNING:** Rear facing child seats should NEVER be placed in front of an active airbag.

2. Slide the tongue up the webbing.

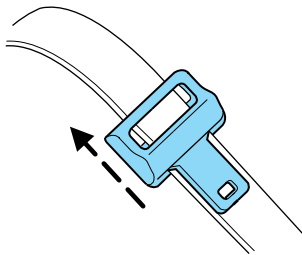

## Seating and Safety Restraints

3. While holding both shoulder and lap portions next to the tongue, route the tongue and webbing through the child seat according to the child seat manufacturer's instructions. Be sure that the belt webbing is not twisted.

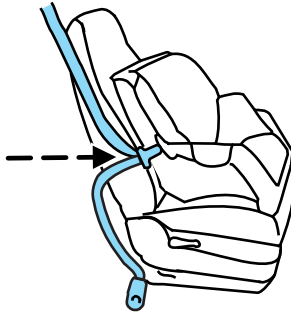

4. Insert the belt tongue into the proper buckle for that seating positions until you hear a snap and feel it latch. Make sure the tongue is securely latched to the buckle by pulling on the tongue.

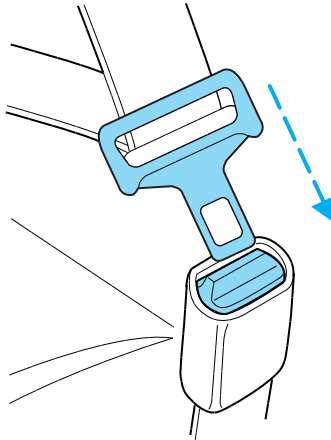



## Seating and Safety Restraints

5. Remove remaining slack from the belt. Force the seat down with extra weight, e.g., by pressing down or kneeling on the child restraint while pulling up on the shoulder belt in order to force slack from the belt. This is necessary to remove the remaining slack that will exist once the additional weight of the child is added to the child restraint. It also helps to achieve the proper snugness of the child seat to the vehicle. Sometimes, a slight lean towards the buckle will additionally help to remove remaining slack from the belt.

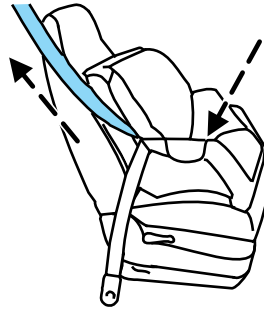

6. Attach the tether strap (if the child seat is equipped). Refer to *Attaching child safety seats with tether straps* later in this chapter.

7. Before placing the child in the seat, forcibly move the seat forward and back to make sure the seat is securely held in place. To check this, grab the seat at the belt path and attempt to move it side to side and forward and back. There should be no more than one inch (2.5 cm) of movement for proper installation.

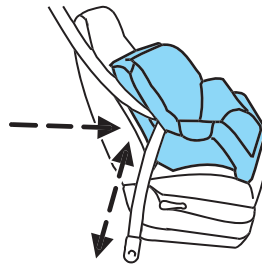

8. Ford recommends checking with a NHTSA Certified Child Passenger Safety Technician (CPST) to make certain the child restraint is properly installed.

### **Attaching child safety seats with Lower Anchor and Tethers for Children (LATCH) attachments**

The LATCH system is composed of three vehicle anchor points: two (2) lower anchors located where the vehicle seat back and seat cushion meet (called the “seat bight”) and one (1) top tether anchor located behind that seating position.

LATCH compatible child safety seats have two rigid or webbing mounted attachments that connect to the two lower anchors at the LATCH equipped seating positions in your vehicle. This type of attachment

## Seating and Safety Restraints

method eliminates the need to use safety belts to attach the child seat, however the safety belt can still be used to attach the child seat. For forward-facing child seats, the top tether strap must also be attached to the proper top tether anchor, if a top tether strap has been provided with your child seat. Ford Motor Company recommends the use of a child safety seat having a top tether strap. See *Attaching child safety seats with tether straps* and *Recommendations for attaching safety restraints for children* in this chapter for more information.

Your vehicle has LATCH lower anchors for child seat installation at the seating positions marked with the child seat symbol.

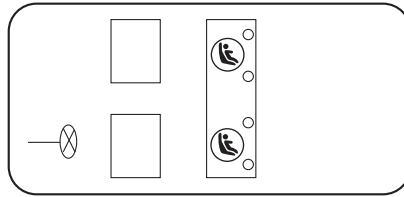

The LATCH anchors are located at the rear section of the rear seat between the cushion and seatback. Follow the child seat manufacturer's instructions to properly install a child seat with LATCH attachments.

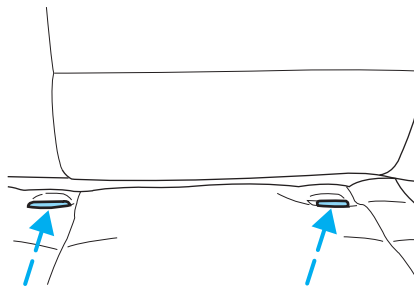

Follow the instructions on attaching child safety seats with tether straps. Refer to *Attaching child safety seats with tether straps* later in this chapter.

Attach LATCH lower attachments of the child seat only to the anchors shown.

**!** **WARNING:** Never attach two child safety seats to the same anchor. In a crash, one anchor may not be strong enough to hold two child safety seat attachments and may break, causing serious injury or death.

## Seating and Safety Restraints



**WARNING:** Depending on where you secure a child restraint, and depending on the child restraint design, you may block access to certain safety belt buckle assemblies and/or LATCH lower anchors, rendering those features potentially unusable. To avoid risk of injury, occupants should only use seating positions where they are able to be properly restrained.

### ***Use of inboard lower anchors from the outboard seating positions (center seating use)***

The lower anchors at the center of the second row rear seat are spaced 450 mm (18 inches) apart. The standardized spacing for LATCH lower anchors is 280 mm (11 inches) center to center. A child seat with rigid LATCH attachments cannot be installed at the center seating position. LATCH compatible child seats (with attachments on belt webbing) can only be used at this seating position provided that the child seat manufacturer's instructions permit use with the anchor spacing stated. Do not attach a child seat to any lower anchor if an adjacent child seat is attached to that anchor.



**WARNING:** The standardized spacing for LATCH lower anchors is 280 mm (11 inches) center to center. Do not use LATCH lower anchors for the center seating position unless the child seat manufacturer's instructions permit and specify using anchors spaced at least as far apart as those in this vehicle.

If you install a child seat with rigid LATCH attachments, do not tighten the tether strap enough to lift the child seat off the vehicle seat cushion when the child is seated in it. Keep the tether strap just snug without lifting the front of the child seat. Keeping the child seat just touching the vehicle seat gives the best protection in a severe crash.

Each time you use the safety seat, check that the seat is properly attached to the lower anchors and tether anchor, if applicable. Tug the child seat from side to side and forward and back where it is secured to the vehicle. The seat should move less than one inch when you do this for a proper installation.

If the safety seat is not anchored properly, the risk of a child being injured in a crash greatly increases.

## Seating and Safety Restraints

### **Combining safety belt and LATCH lower anchors for attaching child safety seats**

When used in combination, either the safety belt or the LATCH lower anchors may be attached first, provided a proper installation is achieved. Attach the tether strap afterward, if included with the child seat. Refer to *Recommendations for attaching safety restraints for children* in this chapter.

### **Attaching child safety seats with tether straps**

Many forward-facing child safety seats include a tether strap which extends from the back of the child safety seat and hooks to an anchoring point called the top tether anchor. Tether straps are available as an accessory for many older safety seats. Contact the manufacturer of your child seat for information about ordering a tether strap, or to obtain a longer tether strap if the tether strap on your safety seat does not reach the appropriate top tether anchor in the vehicle.

The rear seats of your vehicle are equipped with built-in tether strap anchors located behind the seats as described below.

The tether anchors in your vehicle are located under a cover marked with the tether anchor symbol (shown with title).

The tether strap anchors in your vehicle are in the following positions (shown from top view):

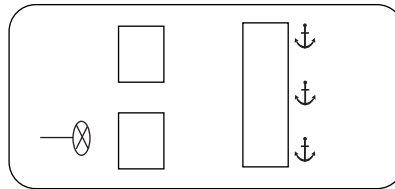

Attach the tether strap only to the appropriate tether anchor as shown. The tether strap may not work properly if attached somewhere other than the correct tether anchor.

Once the child safety seat has been installed using either the safety belt, the lower anchors of the LATCH system, or both, you can attach the top tether strap.

Perform the following steps to install a child safety seat with tether anchors:

1. Route the child safety seat tether strap over the back of the seat.

For vehicles with adjustable head restraints, route the tether strap under the head restraint and between the head restraint posts, otherwise route the tether strap over the top of the seatback.

## Seating and Safety Restraints

2. Locate the correct anchor for the selected seating position.



3. Open the tether anchor cover.

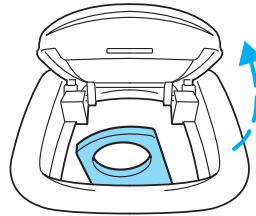

4. Clip the tether strap to the anchor as shown.

If the tether strap is clipped incorrectly, the child safety seat may not be retained properly in the event of a collision.

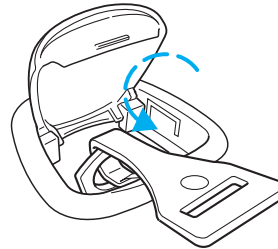

5. Tighten the child safety seat tether strap according to the manufacturer's instructions.

If the safety seat is not anchored properly, the risk of a child being injured in a collision greatly increases.

### Child booster seats

The belt-positioning booster (booster seat) is used to improve the fit of the vehicle safety belt. Children outgrow a typical child seat (e.g., convertible or toddler seat) when they weigh about 40 lb (18 kg) and are around four (4) years of age. Consult your child safety seat owner guide for the weight, height, and age limits specific to your child safety seat. Keep your child in the child safety seat if it properly fits the child, remains appropriate for their weight, height and age AND if properly secured to the vehicle.

## Seating and Safety Restraints

Although the lap/shoulder belt will provide some protection, children who have outgrown a typical child seat are still too small for lap/shoulder belts to fit properly, and wearing an improperly fitted vehicle safety belt could increase the risk of serious injury in a crash. To improve the fit of both the lap and shoulder belt on children who have outgrown child safety seats, Ford Motor Company recommends use of a belt-positioning booster.

Booster seats position a child so that vehicle lap/shoulder safety belts fit better. They lift the child up so that the lap belt rests low across the hips and the knees bend comfortably at the edge of the cushion, while minimizing slouching. Booster seats may also make the shoulder belt fit better and more comfortably. Try to keep the belt near the middle of the shoulder and across the center of the chest. Moving the child closer (a few centimeters or inches) to the center of the vehicle, but remaining in the same seating position, may help provide a good shoulder belt fit.

### **When children should use booster seats**

Children need to use booster seats from the time they outgrow the toddler seat until they are big enough for the vehicle seat and lap/shoulder belt to fit properly. Generally this is when they reach a height of at least 4 feet 9 inches (1.45 meters) tall (around age eight to age twelve and between 40 lb (18 kg) and 80 lb (36 kg) or upward to 100 lb (45 kg) if recommended by your child restraint manufacturer). Many state and provincial laws require that children use approved booster seats until they reach age eight, a height of 4 feet 9 inches (1.45 meters) tall, or 80 lb (36 kg).

Booster seats should be used until you can answer YES to ALL of these questions when seated without a booster seat:

- Can the child sit all the way back against the vehicle seat back with knees bent comfortably at the edge of the seat cushion?
- Can the child sit without slouching?

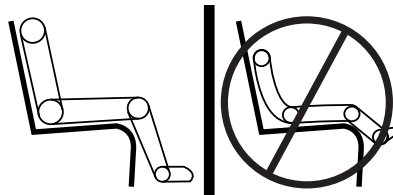

- Does the lap belt rest low across the hips?
- Is the shoulder belt centered on the shoulder and chest?
- Can the child stay seated like this for the whole trip?

## Seating and Safety Restraints

### **Types of booster seats**

There are generally two types of belt-positioning booster seats: backless and high back. Always use booster seats in conjunction with the vehicle lap/shoulder belt.

- **Backless booster seats**

If your backless booster seat has a removable shield, remove the shield. If a vehicle seating position has a low seat back or no head restraint, a backless booster seat may place your child's head (as measured at the tops of the ears) above the top of the seat. In this case, move the backless booster to another seating position with a higher seat back or head restraint and lap/shoulder belts, or consider using a high back booster seat.



- **High back booster seats**

If, with a backless booster seat, you cannot find a seating position that adequately supports your child's head, a high back booster seat would be a better choice.



## Seating and Safety Restraints

Children and booster seats vary in size and shape. Choose a booster that keeps the lap belt low and snug across the hips, never up across the stomach, and lets you adjust the shoulder belt to cross the chest and rest snugly near the center of the shoulder. The drawings below compare the ideal fit (center) to a shoulder belt uncomfortably close to the neck and a shoulder belt that could slip off the shoulder. The drawings below also show how the lap belt should be low and snug across the child's hips.

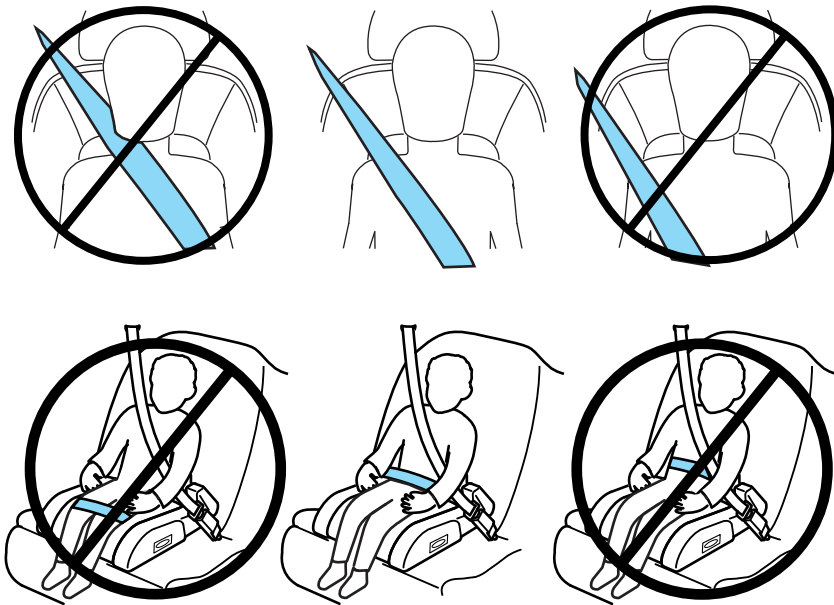

If the booster seat slides on the vehicle seat, placing a rubberized mesh sold as shelf or carpet liner under the booster seat may improve this condition. Do not introduce any item thicker than this under the booster seat. Check with the booster seat manufacturer's instructions.



## Seating and Safety Restraints

### **The importance of shoulder belts**

Using a booster without a shoulder belt increases the risk of a child's head hitting a hard surface in a collision. For this reason, you should never use a booster seat with a lap belt only. It is generally best to use a booster seat with lap/shoulder belts in the back seat.

Move a child to a different seating location if the shoulder belt does not stay positioned on the shoulder during use.

Follow all instructions provided by the manufacturer of the booster seat.



**WARNING:** Never place, or allow a child to place, the shoulder belt under a child's arm or behind the back because it reduces the protection for the upper part of the body and may increase the risk of injury or death in a collision.

### **Child restraint and safety belt maintenance**

Inspect the vehicle safety belts and child safety seat systems periodically to make sure they work properly and are not damaged. Inspect the vehicle and child seat safety belts to make sure there are no nicks, tears or cuts. Replace if necessary. All vehicle safety belt assemblies, including retractors, buckles, front safety belt buckle assemblies, buckle support assemblies (slide bar-if equipped), shoulder belt height adjusters (if equipped), shoulder belt guide on seatback (if equipped), child safety seat LATCH and tether anchors, and attaching hardware, should be inspected after a collision. Refer to the child restraint manufacturer's instructions for additional inspection and maintenance information specific to the child restraint. Ford Motor Company recommends that all safety belt assemblies in use in vehicles involved in a collision be replaced. However, if the collision was minor and an authorized dealer finds that the belts do not show damage and continue to operate properly, they do not need to be replaced. Safety belt assemblies not in use during a collision should also be inspected and replaced if either damage or improper operation is noted.

For proper care of soiled safety belts, refer to *Interior* in the *Cleaning* chapter.



**WARNING:** Failure to inspect and if necessary replace the safety belt assembly or child restraint system under the above conditions could result in severe personal injuries in the event of a collision.

## Tires, Wheels and Loading

### INFORMATION ABOUT UNIFORM TIRE QUALITY GRADING

Tire Quality Grades apply to new pneumatic passenger car tires. The Quality grades can be found where applicable on the tire sidewall between tread shoulder and maximum section width. For example:

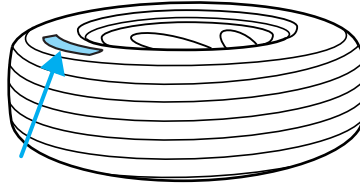

- **Treadwear 200 Traction AA Temperature A**

These Tire Quality Grades are determined by standards that the United States Department of Transportation has set.

Tire Quality Grades apply to new pneumatic passenger car tires. They do not apply to deep tread, winter-type snow tires, space-saver or temporary use spare tires, light truck or “LT” type tires, tires with nominal rim diameters of 10 to 12 inches or limited production tires as defined in Title 49 Code of Federal Regulations Part 575.104(c)(2).

**U.S. Department of Transportation-Tire quality grades:** The U.S. Department of Transportation requires Ford Motor Company to give you the following information about tire grades exactly as the government has written it.

#### **Treadwear**

The treadwear grade is a comparative rating based on the wear rate of the tire when tested under controlled conditions on a specified government test course. For example, a tire graded 150 would wear one and one-half (1½) times as well on the government course as a tire graded 100. The relative performance of tires depends upon the actual conditions of their use, however, and may depart significantly from the norm due to variations in driving habits, service practices, and differences in road characteristics and climate.

#### **Traction AA A B C**

The traction grades, from highest to lowest are AA, A, B, and C. The grades represent the tire’s ability to stop on wet pavement as measured under controlled conditions on specified government test surfaces of asphalt and concrete. A tire marked C may have poor traction performance.

## Tires, Wheels and Loading



**WARNING:** The traction grade assigned to this tire is based on straight-ahead braking traction tests, and does not include acceleration, cornering, hydroplaning or peak traction characteristics.

### Temperature A B C

The temperature grades are A (the highest), B and C, representing the tire's resistance to the generation of heat and its ability to dissipate heat when tested under controlled conditions on a specified indoor laboratory test wheel. Sustained high temperature can cause the material of the tire to degenerate and reduce tire life, and excessive temperature can lead to sudden tire failure. The grade C corresponds to a level of performance which all passenger car tires must meet under the Federal Motor Vehicle Safety Standard No. 139. Grades B and A represent higher levels of performance on the laboratory test wheel than the minimum required by law.



**WARNING:** The temperature grade for this tire is established for a tire that is properly inflated and not overloaded. Excessive speed, underinflation, or excessive loading, either separately or in combination, can cause heat buildup and possible tire failure.

### TIRES

Tires are designed to give many thousands of miles of service, but they must be maintained in order to get the maximum benefit from them.

#### Glossary of tire terminology

- **Tire label:** A label showing the OE (Original Equipment) tire sizes, recommended inflation pressure and the maximum weight the vehicle can carry.
- **Tire Identification Number (TIN):** A number on the sidewall of each tire providing information about the tire brand and manufacturing plant, tire size and date of manufacture. Also referred to as DOT code.
- **Inflation pressure:** A measure of the amount of air in a tire.
- **Standard load:** A class of P-metric or Metric tires designed to carry a maximum load at 35 psi [37 psi (2.5 bar) for Metric tires]. Increasing the inflation pressure beyond this pressure will not increase the tire's load carrying capability.
- **Extra load:** A class of P-metric or Metric tires designed to carry a heavier maximum load at 41 psi [43 psi (2.9 bar) for Metric tires].

## Tires, Wheels and Loading

Increasing the inflation pressure beyond this pressure will not increase the tire's load carrying capability.

- **kPa:** Kilopascal, a metric unit of air pressure.
- **PSI:** Pounds per square inch, a standard unit of air pressure.
- **Cold inflation pressure:** The tire pressure when the vehicle has been stationary and out of direct sunlight for an hour or more and prior to the vehicle being driven for 1 mile (1.6 km).
- **Recommended inflation pressure:** The cold inflation pressure found on the Safety Compliance Certification Label or Tire Label located on the B-Pillar or the edge of the driver's door.
- **B-pillar:** The structural member at the side of the vehicle behind the front door.
- **Bead area of the tire:** Area of the tire next to the rim.
- **Sidewall of the tire:** Area between the bead area and the tread.
- **Tread area of the tire:** Area of the perimeter of the tire that contacts the road when mounted on the vehicle.
- **Rim:** The metal support (wheel) for a tire or a tire and tube assembly upon which the tire beads are seated.

### INFLATING YOUR TIRES

Safe operation of your vehicle requires that your tires are properly inflated. Remember that a tire can lose up to half of its air pressure without appearing flat.

Every day before you drive, check your tires. If one looks lower than the others, use a tire gauge to check pressure of all tires and adjust if required.

At least once a month and before long trips, inspect each tire and check the tire pressure with a tire gauge (including spare, if equipped). Inflate all tires to the inflation pressure recommended by Ford Motor Company.

You are strongly urged to buy a reliable tire pressure gauge, as automatic service station gauges may be inaccurate. Ford recommends the use of a digital or dial-type tire pressure gauge rather than a stick-type tire pressure gauge.

Use the recommended cold inflation pressure for optimum tire performance and wear. Under-inflation or over-inflation may cause uneven treadwear patterns.

## Tires, Wheels and Loading



**WARNING:** Under-inflation is the most common cause of tire failures and may result in severe tire cracking, tread separation or "blowout", with unexpected loss of vehicle control and increased risk of injury. Under-inflation increases sidewall flexing and rolling resistance, resulting in heat buildup and internal damage to the tire. It also may result in unnecessary tire stress, irregular wear, loss of vehicle control and accidents. A tire can lose up to half of its air pressure and not appear to be flat!

Always inflate your tires to the Ford recommended inflation pressure even if it is less than the maximum inflation pressure information found on the tire. The Ford recommended tire inflation pressure is found on the Safety Compliance Certification Label or Tire Label which is located on the B-Pillar or the edge of the driver's door. Failure to follow the tire pressure recommendations can cause uneven treadwear patterns and adversely affect the way your vehicle handles.

**Maximum Permissible Inflation Pressure** is the tire manufacturer's maximum permissible pressure and/or the pressure at which the maximum load can be carried by the tire. This pressure is normally higher than the manufacturer's recommended cold inflation pressure which can be found on the Safety Compliance Certification Label or Tire Label which is located on the B-Pillar or the edge of the driver's door. The cold inflation pressure should never be set lower than the recommended pressure on the Safety Compliance Certification Label or Tire Label.

When weather temperature changes occur, tire inflation pressures also change. A 10°F (6°C) temperature drop can cause a corresponding drop of 1 psi (7 kPa) in inflation pressure. Check your tire pressures frequently and adjust them to the proper pressure which can be found on the Safety Compliance Certification Label or Tire Label.

To check the pressure in your tire(s):

1. Make sure the tires are cool, meaning they are not hot from driving even a mile.

If you are checking tire pressure when the tire is hot, (i.e. driven more than 1 mile [1.6 km]), never "bleed" or reduce air pressure. The tires are hot from driving and it is normal for pressures to increase above recommended cold pressures. A hot tire at or below recommended cold inflation pressure could be significantly under-inflated.

## Tires, Wheels and Loading

**Note:** If you have to drive a distance to get air for your tire(s), check and record the tire pressure first and add the appropriate air pressure when you get to the pump. It is normal for tires to heat up and the air pressure inside to go up as you drive.

2. Remove the cap from the valve on one tire, then firmly press the tire gauge onto the valve and measure the pressure.

3. Add enough air to reach the recommended air pressure.

**Note:** If you overfill the tire, release air by pushing on the metal stem in the center of the valve. Then recheck the pressure with your tire gauge.

4. Replace the valve cap.

5. Repeat this procedure for each tire, including the spare.

**Note:** Some spare tires operate at a higher inflation pressure than the other tires. For T-type/mini-spare tires (see the *Dissimilar spare tire/wheel information* section for description): Store and maintain at 60 psi (4.15 bar). For Full Size and Dissimilar spare tires (see the *Dissimilar spare tire/wheel information* section for description): Store and maintain at the higher of the front and rear inflation pressure as shown on the Tire Label.

6. Visually inspect the tires to make sure there are no nails or other objects embedded that could poke a hole in the tire and cause an air leak.

7. Check the sidewalls to make sure there are no gouges, cuts or bulges.

### TIRE CARE

#### Inspecting your tires

Periodically inspect the tire treads for uneven or excessive wear and remove objects such as stones, nails or glass that may be wedged in the tread grooves. Check for holes or cuts that may permit air leakage from the tire and make necessary repairs. Also inspect the tire sidewalls for cracking, cuts, bruises and other signs of damage or excessive wear. If internal damage to the tire is suspected, have the tire demounted and inspected in case it needs to be repaired or replaced. For your safety, tires that are damaged or show signs of excessive wear should not be used because they are more likely to blow out or fail.

## Tires, Wheels and Loading

Improper or inadequate vehicle maintenance can cause tires to wear abnormally. Inspect all your tires, including the spare, frequently, and replace them if one or more of the following conditions exist:

### Tire wear

When the tread is worn down to 1/16th of an inch (2 mm), tires must be replaced to help prevent your vehicle from skidding and hydroplaning. Built-in treadwear indicators, or “wear bars”, which look like narrow strips of smooth rubber across the tread will appear on the tire when the tread is worn down to 1/16th of an inch (2 mm).

When the tire tread wears down to the same height as these “wear bars”, the tire is worn out and must be replaced.

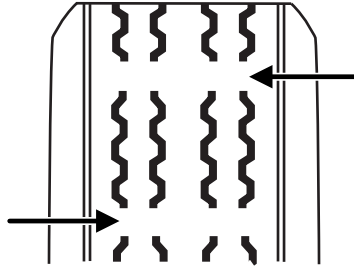

### Damage

Periodically inspect the tire treads and sidewalls for damage (such as bulges in the tread or sidewalls, cracks in the tread groove and separation in the tread or sidewall). If damage is observed or suspected have the tire inspected by a tire professional. Tires can be damaged during off-road use, so inspection after off-road use is also recommended.



### **WARNING: Age**

Tires degrade over time depending on many factors such as weather, storage conditions, and conditions of use (load, speed, inflation pressure, etc.) the tires experience throughout their lives. In general, tires should be replaced after six years regardless of tread wear. However, heat caused by hot climates or frequent high loading conditions can accelerate the aging process and may require tires to be replaced more frequently.

You should replace your spare tire when you replace the road tires or after six years due to aging even if it has not been used.

## Tires, Wheels and Loading

### U.S. DOT Tire Identification Number (TIN)

Both U.S. and Canada Federal regulations require tire manufacturers to place standardized information on the sidewall of all tires. This information identifies and describes the fundamental characteristics of the tire and also provides a U.S. DOT Tire Identification Number for safety standard certification and in case of a recall.

This begins with the letters "DOT" and indicates that the tire meets all federal standards. The next two numbers or letters are the plant code designating where it was manufactured, the next two are the tire size code and the last four numbers represent the week and year the tire was built. For example, the numbers 317 mean the 31st week of 1997. After 2000 the numbers go to four digits. For example, 2501 means the 25th week of 2001. The numbers in between are identification codes used for traceability. This information is used to contact customers if a tire defect requires a recall.

### Tire Replacement Requirements

Your vehicle is equipped with tires designed to provide a safe ride and handling capability.



**WARNING:** Only use replacement tires and wheels that are the same size, load index, speed rating and type (such as P-metric versus LT-metric or all-season versus all-terrain) as those originally provided by Ford. The recommended tire and wheel size may be found on either the Safety Compliance Certification Label or the Tire Label which is located on the B-Pillar or edge of the driver's door. If this information is not found on these labels then you should contact your authorized dealer as soon as possible. Use of any tire or wheel not recommended by Ford can affect the safety and performance of your vehicle, which could result in an increased risk of loss of vehicle control, vehicle rollover, personal injury and death. Additionally the use of non-recommended tires and wheels could cause steering, suspension, axle or transfer case/power transfer unit failure. If you have questions regarding tire replacement, contact your authorized dealer as soon as possible.



## Tires, Wheels and Loading



**WARNING:** When mounting replacement tires and wheels, you should not exceed the maximum pressure indicated on the sidewall of the tire to set the beads without additional precautions listed below. If the beads do not seat at the maximum pressure indicated, re-lubricate and try again.

When inflating the tire for mounting pressures up to 20 psi greater than the maximum pressure on the tire sidewall, the following precautions must be taken to protect the person mounting the tire:

1. Make sure that you have the correct tire and wheel size.
2. Lubricate the tire bead and wheel bead seat area again.
3. Stand at a minimum of 12 ft. (3.66 m) away from the tire wheel assembly.
4. Use both eye and ear protection.

For a mounting pressure more than 20 psi greater than the maximum pressure, a Ford Dealer or other tire service professional should do the mounting.

Always inflate steel carcass tires with a remote air fill with the person inflating standing at a minimum of 12 ft. (3.66 m) away from the tire wheel assembly.

**Important:** Remember to replace the wheel valve stems when the road tires are replaced on your vehicle.

It is recommended that the two front tires or two rear tires generally be replaced as a pair.

The tire pressure sensors mounted in the wheels (if equipped) are not designed to be used in aftermarket wheels.

The use of wheels or tires not recommended by Ford Motor Company may affect the operation of your Tire Pressure Monitoring System (if equipped).

If the TPMS indicator is flashing, your TPMS is malfunctioning. Your replacement tire might be incompatible with your TPMS, or some component of the TPMS may be damaged (if equipped).

### Safety practices

Driving habits have a great deal to do with your tire mileage and safety.

- Observe posted speed limits
- Avoid fast starts, stops and turns
- Avoid potholes and objects on the road
- Do not run over curbs or hit the tire against a curb when parking

## Tires, Wheels and Loading



**WARNING:** If your vehicle is stuck in snow, mud, sand, etc., **do not** rapidly spin the tires; spinning the tires can tear the tire and cause an explosion. A tire can explode in as little as three to five seconds.



**WARNING:** Do not spin the wheels at over 35 mph (56 km/h). The tires may fail and injure a passenger or bystander.

### Highway hazards

No matter how carefully you drive there's always the possibility that you may eventually have a flat tire on the highway. Drive slowly to the closest safe area out of traffic. This may further damage the flat tire, but your safety is more important.

If you feel a sudden vibration or ride disturbance while driving, or you suspect your tire or vehicle has been damaged, immediately reduce your speed. Drive with caution until you can safely pull off the road. Stop and inspect the tires for damage. If a tire is under-inflated or damaged, deflate it, remove wheel and replace it with your spare tire and wheel. If you cannot detect a cause, have the vehicle towed to the nearest repair facility or tire dealer to have the vehicle inspected.

### Tire and wheel alignment

A bad jolt from hitting a curb or pothole can cause the front end of your vehicle to become misaligned or cause damage to your tires. If your vehicle seems to pull to one side when you're driving, the wheels may be out of alignment. Have an authorized dealer check the wheel alignment periodically.

Wheel misalignment in the front or the rear can cause uneven and rapid treadwear of your tires and should be corrected by an authorized dealer. Front wheel drive (FWD) vehicles and those with an independent rear suspension (if equipped) may require alignment of all four wheels.

The tires should also be balanced periodically. An unbalanced tire and wheel assembly may result in irregular tire wear.

### Tire rotation

Rotating your tires at the recommended interval (as indicated in the *scheduled maintenance information* that comes with your vehicle) will help your tires wear more evenly, providing better tire performance and longer tire life.

## Tires, Wheels and Loading

- Front Wheel Drive (FWD) vehicles (front tires at top of diagram)

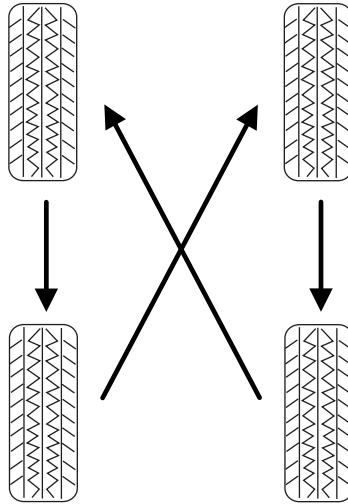

Sometimes irregular tire wear can be corrected by rotating the tires.

**Note:** If your tires show uneven wear ask an authorized dealer to check for and correct any wheel misalignment, tire imbalance or mechanical problem involved before tire rotation.

**Note:** Your vehicle may be equipped with a dissimilar spare tire/wheel. A dissimilar spare tire/wheel is defined as a spare tire and/or wheel that is different in brand, size or appearance from the road tires and wheels. If you have a dissimilar spare tire/wheel it is intended for temporary use only and should not be used in a tire rotation.

**Note:** After having your tires rotated, inflation pressure must be checked and adjusted to the vehicle requirements.

### INFORMATION CONTAINED ON THE TIRE SIDEWALL

Both U.S. and Canada Federal regulations require tire manufacturers to place standardized information on the sidewall of all tires. This information identifies and describes the fundamental characteristics of the tire and also provides a U.S. DOT Tire Identification Number for safety standard certification and in case of a recall.

## Tires, Wheels and Loading

### Information on “P” type tires

P215/65R15 95H is an example of a tire size, load index and speed rating. The definitions of these items are listed below. (Note that the tire size, load index and speed rating for your vehicle may be different from this example.)

1. **P:** Indicates a tire, designated by the Tire and Rim Association (T&RA), that may be used for service on cars, SUVs, minivans and light trucks.

**Note:** If your tire size does not begin with a letter this may mean it is designated by either ETRTO (European Tire and Rim Technical Organization) or JATMA (Japan Tire Manufacturing Association).

2. **215:** Indicates the nominal width of the tire in millimeters from sidewall edge to sidewall edge. In general, the larger the number, the wider the tire.

3. **65:** Indicates the aspect ratio which gives the tire’s ratio of height to width.

4. **R:** Indicates a “radial” type tire.

5. **15:** Indicates the wheel or rim diameter in inches. If you change your wheel size, you will have to purchase new tires to match the new wheel diameter.

6. **95:** Indicates the tire’s load index. It is an index that relates to how much weight a tire can carry. You may find this information in your *Owner’s Guide*. If not, contact a local tire dealer.

**Note:** You may not find this information on all tires because it is not required by federal law.

7. **H:** Indicates the tire’s speed rating. The speed rating denotes the speed at which a tire is designed to be driven for extended periods of time under a standard condition of load and inflation pressure. The tires on your vehicle may operate at different conditions for load and inflation pressure. These speed ratings may need to be adjusted for the difference in conditions. The ratings range from 81 mph (130 km/h) to 186 mph (299 km/h). These ratings are listed in the following chart.

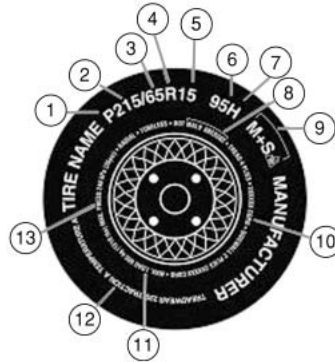

## Tires, Wheels and Loading

**Note:** You may not find this information on all tires because it is not required by federal law.

Letter rating	Speed rating - mph (km/h)
M	81 mph (130 km/h)
N	87 mph (140 km/h)
Q	99 mph (159 km/h)
R	106 mph (171 km/h)
S	112 mph (180 km/h)
T	118 mph (190 km/h)
U	124 mph (200 km/h)
H	130 mph (210 km/h)
V	149 mph (240 km/h)
W	168 mph (270 km/h)
Y	186 mph (299 km/h)

**Note:** For tires with a maximum speed capability over 149 mph (240 km/h), tire manufacturers sometimes use the letters ZR. For those with a maximum speed capability over 186 mph (299 km/h), tire manufacturers always use the letters ZR.

**8. U.S. DOT Tire Identification Number (TIN):** This begins with the letters "DOT" and indicates that the tire meets all federal standards. The next two numbers or letters are the plant code designating where it was manufactured, the next two are the tire size code and the last four numbers represent the week and year the tire was built. For example, the numbers 317 mean the 31st week of 1997. After 2000 the numbers go to four digits. For example, 2501 means the 25th week of 2001. The numbers in between are identification codes used for traceability. This information is used to contact customers if a tire defect requires a recall.

**9. M+S or M/S:** Mud and Snow, or

**AT:** All Terrain, or

**AS:** All Season.

**10. Tire Ply Composition and Material Used:** Indicates the number of plies or the number of layers of rubber-coated fabric in the tire tread and sidewall. Tire manufacturers also must indicate the ply materials in the tire and the sidewall, which include steel, nylon, polyester, and others.

**11. Maximum Load:** Indicates the maximum load in kilograms and pounds that can be carried by the tire. Refer to the Safety Compliance Certification Label, which is located on the B-Pillar or the edge of the driver's door, for the correct tire pressure for your vehicle.

## Tires, Wheels and Loading

### 12. Treadwear, Traction and Temperature Grades

- **Treadwear:** The treadwear grade is a comparative rating based on the wear rate of the tire when tested under controlled conditions on a specified government test course. For example, a tire graded 150 would wear one and one-half ( $1\frac{1}{2}$ ) times as well on the government course as a tire graded 100.
- **Traction:** The traction grades, from highest to lowest are AA, A, B, and C. The grades represent the tire's ability to stop on wet pavement as measured under controlled conditions on specified government test surfaces of asphalt and concrete. A tire marked C may have poor traction performance.
- **Temperature:** The temperature grades are A (the highest), B and C, representing the tire's resistance to the generation of heat and its ability to dissipate heat when tested under controlled conditions on a specified indoor laboratory test wheel.

13. **Maximum Permissible Inflation Pressure:** Indicates the tire manufacturers' maximum permissible pressure and/or the pressure at which the maximum load can be carried by the tire. This pressure is normally higher than the manufacturer's recommended cold inflation pressure which can be found on the Safety Compliance Certification Label or Tire Label which is located on the B-Pillar or the edge of the driver's door. The cold inflation pressure should never be set lower than the recommended pressure on the vehicle label.

The tire suppliers may have additional markings, notes or warnings such as standard load, radial tubeless, etc.

## Tires, Wheels and Loading

### Additional information contained on the tire sidewall for “LT” type tires

“LT” type tires have some additional information beyond those of “P” type tires; these differences are described below.

**Note:** Tire Quality Grades do not apply to this type of tire.

1. **LT:** Indicates a tire, designated by the Tire and Rim Association (T&RA), that is intended for service on light trucks.

#### 2. Load Range/Load Inflation

**Limits:** Indicates the tire’s load-carrying capabilities and its inflation limits.

3. **Maximum Load Dual lb. (kg) at psi (kPa) cold:** Indicates the maximum load and tire pressure when the tire is used as a dual; defined as four tires on the rear axle (a total of six or more tires on the vehicle).

4. **Maximum Load Single lb. (kg) at psi (kPa) cold:** Indicates the maximum load and tire pressure when the tire is used as a single; defined as two tires (total) on the rear axle.

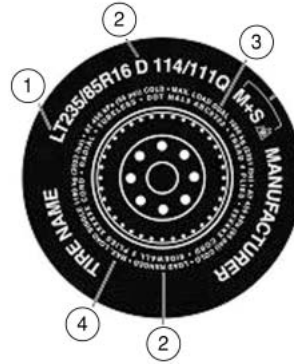

## Tires, Wheels and Loading

### Information on “T” type tires

“T” type tires have some additional information beyond those of “P” type tires; these differences are described below:

T145/80D16 is an example of a tire size.

**Note:** The temporary tire size for your vehicle may be different from this example. Tire Quality Grades do not apply to this type of tire.

1. **T:** Indicates a type of tire, designated by the Tire and Rim Association (T&RA), that is intended for temporary service on cars, SUVs, minivans and light trucks.

2. **145:** Indicates the nominal width of the tire in millimeters from sidewall edge to sidewall edge. In general, the larger the number, the wider the tire.

3. **80:** Indicates the aspect ratio which gives the tire’s ratio of height to width. Numbers of 70 or lower indicate a short sidewall.

4. **D:** Indicates a “diagonal” type tire.

**R:** Indicates a “radial” type tire.

5. **16:** Indicates the wheel or rim diameter in inches. If you change your wheel size, you will have to purchase new tires to match the new wheel diameter.

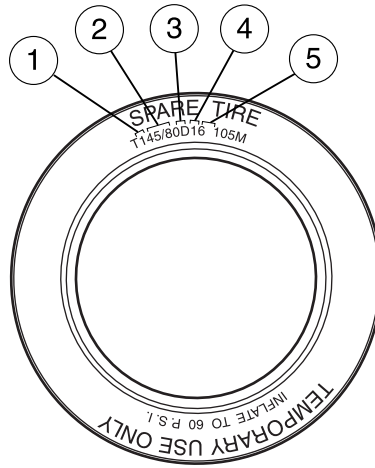

### Location of the tire label

You will find a Tire Label containing tire inflation pressure by tire size and other important information located on the B-Pillar or the edge of the driver’s door.

### TIRE PRESSURE MONITORING SYSTEM (TPMS)

Each tire, including the spare (if provided), should be checked monthly when cold and inflated to the inflation pressure recommended by the vehicle manufacturer on the

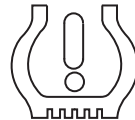



## Tires, Wheels and Loading

vehicle placard or tire inflation pressure label. (If your vehicle has tires of a different size than the size indicated on the vehicle placard or tire inflation pressure label, you should determine the proper tire inflation pressure for those tires.)

As an added safety feature, your vehicle has been equipped with a tire pressure monitoring system (TPMS) that illuminates a low tire pressure telltale when one or more of your tires is significantly under-inflated. Accordingly, when the low tire pressure telltale illuminates, you should stop and check your tires as soon as possible, and inflate them to the proper pressure. Driving on a significantly under-inflated tire causes the tire to overheat and can lead to tire failure. Under-inflation also reduces fuel efficiency and tire tread life, and may affect the vehicle's handling and stopping ability.

Please note that the TPMS is not a substitute for proper tire maintenance, and it is the driver's responsibility to maintain correct tire pressure, even if under-inflation has not reached the level to trigger illumination of the TPMS low tire pressure telltale.

Your vehicle has also been equipped with a TPMS malfunction indicator to indicate when the system is not operating properly. The TPMS malfunction indicator is combined with the low tire pressure telltale.

When the system detects a malfunction, the telltale will flash for approximately one minute and then remain continuously illuminated. This sequence will continue upon subsequent vehicle start-ups as long as the malfunction exists.

When the malfunction indicator is illuminated, the system may not be able to detect or signal low tire pressure as intended. TPMS malfunctions may occur for a variety of reasons, including the installation of replacement or alternate tires or wheels on the vehicle that prevent the TPMS from functioning properly. Always check the TPMS malfunction telltale after replacing one or more tires or wheels on your vehicle to ensure that the replacement or alternate tires and wheels allow the TPMS to continue to function properly.

The Tire Pressure Monitoring System complies with part 15 of the FCC rules and with RSS-210 of Industry Canada. Operation is subject to the following two conditions: (1) This device may not cause harmful interference, and (2) This device must accept any interference received, including interference that may cause undesired operation.



**WARNING:** The Tire Pressure Monitoring System is NOT a substitute for manually checking tire pressure. The tire pressure should be checked periodically (at least monthly) using a tire gauge, see *Inflating your tires* in this chapter. Failure to properly maintain your tire pressure could increase the risk of tire failure, loss of control, vehicle rollover and personal injury.

## Tires, Wheels and Loading

### Changing tires with TPMS

Each road tire is equipped with a tire pressure sensor fastened to the inside rim of the wheel. The pressure sensor is covered by the tire and is not visible unless the tire is removed. The pressure sensor is located opposite (180 degrees) from the valve stem. Care must be taken when changing the tire to avoid damaging the sensor. It is recommended that you always have your tires serviced by an authorized dealer.

The tire pressure should be checked periodically (at least monthly) using an accurate tire gauge, refer to *Inflating your tires* in this chapter.

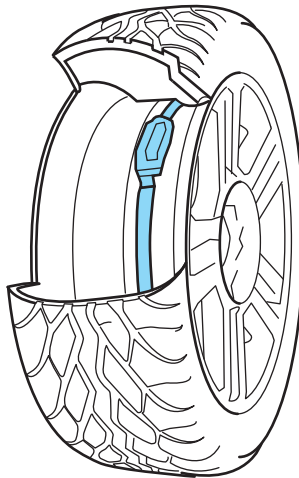

### Understanding your Tire Pressure Monitoring System (TPMS)

The Tire Pressure Monitoring System measures pressure in your four road tires and sends the tire pressure readings to your vehicle. The Low Tire Pressure Warning Lamp will turn ON if the tire pressure is significantly low. Once the light is illuminated, your tires are under inflated and need to be inflated to the manufacturer's recommended tire pressure. Even if the light turns ON and a short time later turns OFF, your tire pressure still needs to be checked. Visit [www.checkmytires.org](http://www.checkmytires.org) for additional information.

### ***When your temporary spare tire is installed***

When one of your road tires needs to be replaced with the temporary spare, the TPMS system will continue to identify an issue to remind you that the damaged road wheel/tire needs to be repaired and put back on your vehicle.

To restore the full functionality of the Tire Pressure Monitoring System, have the damaged road wheel/tire repaired and remounted on your vehicle. For additional information, refer to *Changing tires with TPMS* in this section.

## Tires, Wheels and Loading

### ***When you believe your system is not operating properly***

The main function of the Tire Pressure Monitoring System is to warn you when your tires need air. It can also warn you in the event the system is no longer capable of functioning as intended. Please refer to the following chart for information concerning your Tire Pressure Monitoring System:

<b>Low Tire Pressure Warning Light</b>	<b>Possible cause</b>	<b>Customer Action Required</b>
Solid Warning Light	Tire(s) under-inflated	1. Check your tire pressure to ensure tires are properly inflated; refer to <i>Inflating your tires</i> in this chapter. 2. After inflating your tires to the manufacturer's recommended inflation pressure as shown on the Tire Label (located on the edge of driver's door or the B-Pillar), the vehicle must be driven for at least two minutes over 20 mph (32 km/h) before the light will turn OFF.
	Spare tire in use	Your temporary spare tire is in use. Repair the damaged road wheel/tire and reinstall it on the vehicle to restore system functionality. For a description on how the system functions, refer to <i>When your temporary spare tire is installed</i> in this section.
	TPMS malfunction	If your tires are properly inflated and your spare tire is not in use and the light remains ON, contact your authorized dealer as soon as possible.

## Tires, Wheels and Loading

Low Tire Pressure Warning Light	Possible cause	Customer Action Required
Flashing Warning Light	Spare tire in use	Your temporary spare tire is in use. Repair the damaged road wheel and re-mount it on the vehicle to restore system functionality. For a description of how the system functions under these conditions, refer to <i>When your temporary spare tire is installed</i> in this section.
	TPMS malfunction	If your tires are properly inflated and your spare tire is not in use and the TPMS warning light still flashes, contact your authorized dealer as soon as possible.

### **When inflating your tires**

When putting air into your tires (such as at a gas station or in your garage), the Tire Pressure Monitoring System may not respond immediately to the air added to your tires.

It may take up to two minutes of driving over 20 mph (32 km/h) for the light to turn OFF after you have filled your tires to the recommended inflation pressure.

### **How temperature affects your tire pressure**

The Tire Pressure Monitoring System (TPMS) monitors tire pressure in each pneumatic tire. While driving in a normal manner, a typical passenger tire inflation pressure may increase approximately 2 to 4 psi (14 to 28 kPa) from a cold start situation. If the vehicle is stationary over night with the outside temperature significantly lower than the daytime temperature, the tire pressure may decrease approximately 3 psi (20.7 kPa) for a drop of 30° F (16.6°C) in ambient temperature. This lower pressure value may be detected by the TPMS as being significantly lower than the recommended inflation pressure and activate the TPMS warning for low tire pressure. If the low tire pressure warning light is ON, visually check each tire to verify that no tire is flat. (If one or more tires are flat, repair as necessary.) Check air pressure in the road tires. If any tire is under-inflated, carefully drive the vehicle to the nearest location where air can be added to the tires. Inflate all the tires to the recommended inflation pressure.

## Tires, Wheels and Loading

### SNOW TIRES AND CHAINS



**WARNING:** Snow tires must be the same size, load index, speed rating as those originally provided by Ford. Use of any tire or wheel not recommended by Ford can affect the safety and performance of your vehicle, which could result in an increased risk of loss of vehicle control, vehicle rollover, personal injury and death. Additionally, the use of non-recommended tires and wheels could cause steering, suspension, axle or transfer case/power transfer unit failure.

The original equipment tires on your vehicle have an all-weather tread design to provide traction, handling and braking performance in year-round driving. You may install snow tires for improved traction when driving in areas with sustained periods of snow or icy driving conditions.

If you choose to install snow tires on your vehicle, they must be the same size, construction, and load range as the original tires listed on the tire placard, and they must be installed on all four wheels. Mixing tires of different size or construction on your vehicle can adversely affect your vehicle's handling and braking, and may lead to loss of vehicle control.



**WARNING:** Do not use snow chains or cables on this vehicle as they may cause damage to your vehicle which may lead to loss of vehicle control.

### VEHICLE LOADING – WITH AND WITHOUT A TRAILER

This section will guide you in the proper loading of your vehicle and/or trailer, to keep your loaded vehicle weight within its design rating capability, with or without a trailer. Properly loading your vehicle will provide maximum return of vehicle design performance. Before loading your vehicle, familiarize yourself with the following terms for determining your vehicle's weight ratings, with or without a trailer, from the vehicle's Safety Compliance Certification Label:

**Base Curb Weight** – is the weight of the vehicle including a full tank of fuel and all standard equipment. It does not include passengers, cargo, or optional equipment.

**Vehicle Curb Weight** – is the weight of your new vehicle when you picked it up from your authorized dealer plus any aftermarket equipment.

## Tires, Wheels and Loading



**Cargo Weight** – includes all weight added to the Base Curb Weight, including cargo and optional equipment. When towing, trailer tongue load weight is also part of cargo weight.

**GAW (Gross Axle Weight)** – is the total weight placed on each axle (front and rear) – including vehicle curb weight and all payload.

**GAWR (Gross Axle Weight Rating)** – is the maximum allowable weight that can be carried by a single axle (front or rear). **These numbers are shown on the Safety Compliance Certification Label located on the B-Pillar or the edge of the driver's door. The total load on each axle must never exceed its GAWR.**

**Note:** For trailer towing information refer to *Trailer towing* found in this chapter or the *RV and Trailer Towing Guide* provided by your authorized dealer.

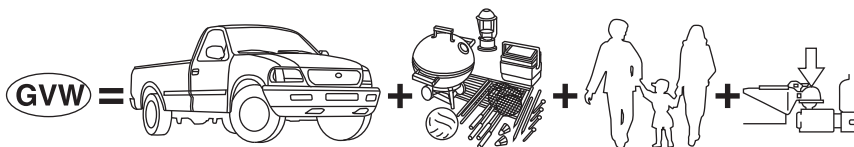

**GVW (Gross Vehicle Weight)** – is the Vehicle Curb Weight + cargo + passengers.

## Tires, Wheels and Loading

**GVWR (Gross Vehicle Weight Rating)** – is the maximum allowable weight of the fully loaded vehicle (including all options, equipment, passengers and cargo). **The GVWR is shown on the Safety Compliance Certification Label located on the B-Pillar or the edge of the driver's door. The GVW must never exceed the GVWR.**

MFD. BY FORD MOTOR CO.					
DATE: XXXX	GVWR: XXXXXLB/ XXXXXKG				
FRONT GAWR: XXXXL	REAR GAWR: XXXXLB				
XXXXKG	WITH	XXXXKG	WITH		
XXXX/XXXXXX	TIRES	XXXX/XXXXXX	TIRES		
XXXX.XX	RIMS	XXXX.XX	RIMS		
AT XXX kPa/XX	PSI COLD	AT XXX kPa/XX	PSI COLD		
THIS VEHICLE CONFORMS TO ALL APPLICABLE FEDERAL MOTOR VEHICLE SAFETY AND THEFT PREVENTION STANDARDS IN EFFECT ON THE DATE OF MANUFACTURE SHOWN ABOVE.					
VIN: XXXXXXXXXXXXXXXX	XXXXX		XXXXX		
TYPE: XXX					
					
EXT PNT: XX	RC: XX	DSO:			
WB <sup>1</sup> BRK <sup>1</sup> INT TR <sup>1</sup> TP/PS <sup>1</sup> TR <sup>1</sup> AXLE <sup>1</sup> TR <sup>1</sup> SPR <sup>1</sup> XXXXX					
XXX X XX X XX X XX XXX					
XXXXXXXXXXXXX XXX XXXX-XXXXXX-XX					

**WARNING:** Exceeding the Safety Compliance Certification Label vehicle weight rating limits could result in substandard vehicle handling or performance, engine, transmission and/or structural damage, serious damage to the vehicle, loss of control and personal injury.



**GCW (Gross Combined Weight)** – is the weight of the loaded vehicle (GVW) plus the weight of the fully loaded trailer.

**GCWR (Gross Combined Weight Rating)** – is the maximum allowable weight of the vehicle and the loaded trailer – including all cargo and passengers – that the vehicle can handle without risking damage. (Important: The towing vehicles' braking system is rated for operation at GVWR, not at GCWR. Separate functional brakes should be used for safe control of towed vehicles and for trailers where the GCW of the towing vehicle plus the trailer exceed the GVWR of the towing vehicle. **The GCW must never exceed the GCWR.**)

## Tires, Wheels and Loading

**Maximum Loaded Trailer Weight** – is the highest possible weight of a fully loaded trailer the vehicle can tow. It assumes a vehicle with only mandatory options, no cargo (internal or external), a tongue load of 10–15% (conventional trailer), and driver only (150 lb. [68 kg]). **Consult your authorized dealer (or the *RV and Trailer Towing Guide* provided by your authorized dealer) for more detailed information.**



**WARNING:** Do not exceed the GVWR or the GAWR specified on the Safety Compliance Certification Label.



**WARNING:** Do not use replacement tires with lower load carrying capacities than the original tires because they may lower the vehicle's GVWR and GAWR limitations. Replacement tires with a higher limit than the original tires do not increase the GVWR and GAWR limitations.



**WARNING:** Exceeding any vehicle weight rating limitation could result in serious damage to the vehicle and/or personal injury.

### Steps for determining the correct load limit:

1. Locate the statement “The combined weight of occupants and cargo should never exceed XXX kg or XXX lbs.” on your vehicle's placard.
2. Determine the combined weight of the driver and passengers that will be riding in your vehicle.
3. Subtract the combined weight of the driver and passengers from XXX kg or XXX lbs.
4. The resulting figure equals the available amount of cargo and luggage load capacity. For example, if the “XXX” amount equals 1,400 lbs. and there will be five 150 lb. passengers in your vehicle, the amount of available cargo and luggage load capacity is 650 lbs. (1400–750 (5 x 150) = 650 lb.). In metric units (635–340 (5 x 68) = 295 kg.)
5. Determine the combined weight of luggage and cargo being loaded on the vehicle. That weight may not safely exceed the available cargo and luggage load capacity calculated in Step 4.
6. If your vehicle will be towing a trailer, load from your trailer will be transferred to your vehicle. Consult this manual to determine how this reduces the available cargo and luggage load capacity of your vehicle.



## Tires, Wheels and Loading

The following gives you a few examples on how to calculate the available amount of cargo and luggage load capacity:

- Another example for your vehicle with 1400 lb. (635 kg) of cargo and luggage capacity. You decide to go golfing. Is there enough load capacity to carry you, 4 of your friends and all the golf bags? You and four friends average 220 lb. (99 kg) each and the golf bags weigh approximately 30 lb. (13.5 kg) each. The calculation would be:  $1400 - (5 \times 220) - (5 \times 30) = 1400 - 1100 - 150 = 150$  lb. Yes, you have enough load capacity in your vehicle to transport four friends and your golf bags. In metric units, the calculation would be:  $635 \text{ kg} - (5 \times 99 \text{ kg}) - (5 \times 13.5 \text{ kg}) = 635 - 495 - 67.5 = 72.5$  kg.
- A final example for your vehicle with 1400 lb. (635 kg) of cargo and luggage capacity. You and one of your friends decide to pick up cement from the local home improvement store to finish that patio you have been planning for the past 2 years. Measuring the inside of the vehicle with the rear seat folded down, you have room for 12-100 lb. (45 kg) bags of cement. Do you have enough load capacity to transport the cement to your home? If you and your friend each weigh 220 lb. (99 kg), the calculation would be:  $1400 - (2 \times 220) - (12 \times 100) = 1400 - 440 - 1200 = -240$  lb. No, you do not have enough cargo capacity to carry that much weight. In metric units, the calculation would be:  $635 \text{ kg} - (2 \times 99 \text{ kg}) - (12 \times 45 \text{ kg}) = 635 - 198 - 540 = -103$  kg. You will need to reduce the load weight by at least 240 lb. (104 kg). If you remove 3-100 lb. (45 kg) cement bags, then the load calculation would be:  
 $1400 - (2 \times 220) - (9 \times 100) = 1400 - 440 - 900 = 60$  lb. Now you have the load capacity to transport the cement and your friend home. In metric units, the calculation would be:  $635 \text{ kg} - (2 \times 99 \text{ kg}) - (9 \times 45 \text{ kg}) = 635 - 198 - 405 = 32$  kg.

The above calculations also assume that the loads are positioned in your vehicle in a manner that does not overload the Front or the Rear Gross Axle Weight Rating specified for your vehicle on the Safety Compliance Certification Label found on the edge of the driver's door.

### TRAILER TOWING



**WARNING:** Never tow a trailer with this vehicle. Your vehicle is not equipped to tow. No towing packages are available through an authorized dealer.

## Tires, Wheels and Loading

### RECREATIONAL TOWING

Follow these guidelines if you have a need for recreational (RV) towing. An example of recreational towing would be towing your vehicle behind a motorhome. These guidelines are designed to ensure that your transmission is not damaged.

**Note:** Put your climate control system in recirculated air mode to prevent exhaust fumes from entering the vehicle. Refer to the *Climate controls* chapter for more information.

**Front Wheel Drive (FWD) vehicles with manual transmissions:** If your vehicle is equipped with a manual transmission, shifting the transmission into neutral (N) permits “flat-towing” (all wheels on the ground) for pulling behind a motorhome.

Before you tow your vehicle:

- Release the parking brake.
- Move the gearshift to the neutral position.
- Turn the key in the ignition to the off position.
- The maximum recommended speed is 70 mph (113 km/h).
- The maximum recommended distance is unlimited.
- The vehicle must be towed in the forward position to ensure no damage is done to the internal transmission components.

In addition, it is recommended that you follow the instructions provided by the aftermarket manufacturer of the towing equipment, if provided.

In case of a roadside emergency with a disabled vehicle, see *Wrecker towing* in the *Roadside Emergencies* chapter.

### **Front Wheel Drive (FWD) vehicles with automatic transmissions:**

Do not tow the vehicle with the front drive wheels on the ground. It is recommended to tow your vehicle with the front drive wheels on a dolly or with all four (4) wheels off the ground on a car-hauling trailer.

In case of a roadside emergency with a disabled vehicle, see *Wrecker towing* in the *Roadside Emergencies* chapter.

### STARTING

#### Positions of the ignition

1. Off — locks the steering wheel, automatic transmission gearshift lever and allows key removal. This position also shuts the engine and all electrical accessories off.

2. Accessory—allows the electrical accessories such as the radio to operate while the engine is not running.

3. On— all electrical circuits operational. Warning lights illuminated. Key position when driving.

4. Start— cranks the engine. Release the key as soon as the engine starts.

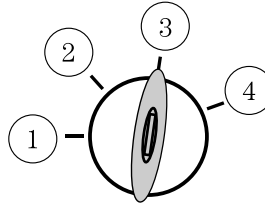

#### Preparing to start your vehicle

Engine starting is controlled by the powertrain control system.

This system meets all Canadian Interference-Causing Equipment standard requirements regulating the impulse electrical field strength of radio noise.

When starting a fuel-injected engine, don't press the accelerator before or during starting. Only use the accelerator when you have difficulty starting the engine. For more information on starting the vehicle, refer to *Starting the engine* in this chapter.



**WARNING:** Extended idling at high engine speeds can produce very high temperatures in the engine and exhaust system, creating the risk of fire or other damage.



**WARNING:** Do not park, idle, or drive your vehicle in dry grass or other dry ground cover. The emission system heats up the engine compartment and exhaust system, which can start a fire.



**WARNING:** Do not start your vehicle in a closed garage or in other enclosed areas. Exhaust fumes can be toxic. Always open the garage door before you start the engine. See *Guarding against exhaust fumes* in this chapter for more instructions.

## Driving



**WARNING:** If you smell exhaust fumes inside your vehicle, have your dealer inspect your vehicle immediately. Do not drive if you smell exhaust fumes.

### ***Important safety precautions***

When the engine starts, the idle RPM runs faster to warm the engine. If the engine idle speed does not slow down automatically, have the vehicle checked.

Before starting the vehicle:

1. Make sure all occupants buckle their safety belts. For more information on safety belts and their proper usage, refer to the *Seating and Safety Restraints* chapter.
2. Make sure the headlamps and electrical accessories are off.

If starting a vehicle with an automatic transaxle:

- Make sure the parking brake is set.

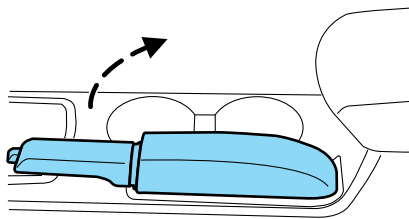

## Driving

- Make sure the gearshift is in P (Park).

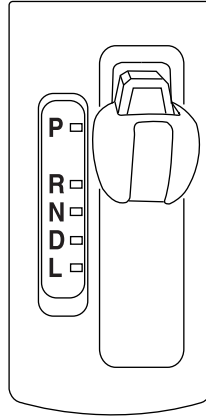

If starting a vehicle with a manual transmission:

1. Make sure the parking brake is set.
2. Push the clutch pedal to the floor.

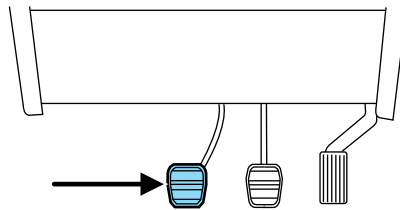

- Turn the key to 3 (on) without turning the key to 4 (start).

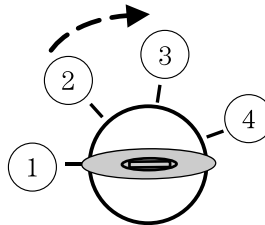

Some warning lights will briefly illuminate. See *Warning lights and chimes* in the *Instrument Cluster* chapter for more information regarding the warning lights.

## Driving

### Starting the engine

1. Turn the key to 3 (on) without turning the key to 4 (start).
2. Turn the key to 4 (start), then release the key as soon as the engine begins cranking. Your vehicle has a computer assisted cranking system that assists in starting the engine. After releasing the key from the 4 (start) position, the engine may continue cranking for up to 10 seconds or until the vehicle starts.

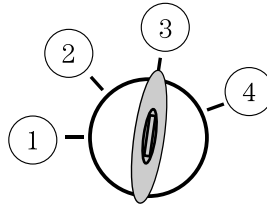

**Note:** Cranking may be stopped at any time by turning the key to the off position.

3. After idling for a few seconds, apply the brake, shift into gear and drive.

**Note:** If the engine does not start on the first try, turn the key to the off position, wait 10 seconds and try Step 2 again. If the engine still fails to start, press the accelerator to the floor and try Step 2 again, keeping the accelerator on the floor until the engine begins to accelerate above cranking speeds; this will allow the engine to crank with the fuel shut off in case the engine is flooded with fuel.

### Guarding against exhaust fumes

Carbon monoxide is present in exhaust fumes. Take precautions to avoid its dangerous effects.



**WARNING:** If you smell exhaust fumes inside your vehicle, have your dealer inspect your vehicle immediately. Do not drive if you smell exhaust fumes.

### Important ventilating information

If the engine is idling while the vehicle is stopped for a long period of time, open the windows at least one inch (2.5 cm) or adjust the heating or air conditioning to bring in fresh air.

### ENGINE BLOCK HEATER (IF EQUIPPED)

An engine block heater warms the engine coolant which aids in starting and allows the heater/defroster system to respond quickly. If your vehicle is equipped with this system, your equipment includes a heater element which is installed in your engine block and a wire harness which allows the user to connect the system to a grounded 120 volt a/c electrical source. The block heater system is most effective when outdoor temperatures reach below 0°F (-18°C).



**WARNING:** Failure to follow engine block heater instructions could result in property damage or physical injury.



**WARNING:** To reduce the risk of electrical shock, do not use your heater with ungrounded electrical systems or two-pronged (cheater) adapters.

Prior to using the engine block heater, follow these recommendations for proper and safe operation:

- For your safety, use an outdoor extension cord that is product certified by Underwriter's Laboratory (UL) or Canadian Standards Association (CSA). Use only an extension cord that can be used outdoors, in cold temperatures, and is clearly marked "Suitable for Use with Outdoor Appliances." Never use an indoor extension cord outdoors; it could result in an electric shock or fire hazard.
- Use a 16 gauge outdoor extension cord, minimum.
- Use as short an extension cord as possible.
- Do not use multiple extension cords. Instead, use one extension cord which is long enough to reach from the engine block heater cord to the outlet without stretching.
- Make certain that the extension cord is in excellent condition (not patched or spliced). Store your extension cord indoors at temperatures above 32°F (0°C). Outdoor conditions can deteriorate extension cords over a period of time.
- To reduce the risk of electrical shock, do not use your heater with ungrounded electrical systems or two pronged (cheater) adapters. Also ensure that the block heater, especially the cord, is in good condition before use.
- Make sure that when in operation, the extension cord plug /engine block heater cord plug connection is free and clear of water in order to prevent possible shock or fire.

## Driving

- Be sure that areas where the vehicle is parked are clean and clear of all combustibles such as petroleum products, dust, rags, paper and similar items.
- Be sure that the engine block heater, heater cord and extension cord are solidly connected. A poor connection can cause the cord to become very hot and may result in an electrical shock or fire. Be sure to check for heat anywhere in the electrical hookup once the system has been operating for approximately a half hour.
- Finally, have the engine block heater system checked during your fall tune-up to be sure it's in good working order.

### How to use the engine block heater

Ensure the receptacle terminals are clean and dry prior to use. To clean them, use a dry cloth.

Depending on the type of factory installed equipment, your engine block heater will use .4 to 1.0 kilowatt-hours of energy per hour of use. Your factory installed block heater system does not have a thermostat; however, maximum temperature is attained after approximately three hours of operation. Block heater operation longer than three hours will not improve system performance and will unnecessarily use additional electricity.

Make sure system is unplugged and properly stowed before driving the vehicle. While not in use, make sure the protective cover seals the prongs of the engine block heater cord plug.

## BRAKES

Occasional brake noise is normal. If a metal-to-metal, continuous grinding or continuous squeal sound is present, the brake linings may be worn-out and should be inspected by an authorized dealer. If the vehicle has continuous vibration or shudder in the steering wheel while braking, the vehicle should be inspected by an authorized dealer.

Refer to *Brake system warning light* in the *Instrument Cluster* chapter for information on the brake system warning light.





Under normal operating conditions, brake dust may accumulate on the wheels. Some brake dust is inevitable as brakes wear and does not contribute to brake noise. The use of modern friction materials with emphasis on improved performance and environmental considerations can lead to more dust than in the past. Brake dust can be cleaned by weekly washing with soapy water and a soft sponge. Heavier deposits can be removed with Motorcraft Wheel and Tire Cleaner (ZC-37-A).

### **Four-wheel anti-lock brake system (ABS) (if equipped)**

Your vehicle may be equipped with an Anti-lock Braking System (ABS). This system helps you maintain steering control during emergency stops by keeping the brakes from locking. Noise from the ABS pump motor and brake pedal pulsation may be observed during ABS braking; any pulsation or mechanical noise you may feel or hear is normal.

### **Using ABS**

When hard braking is required, apply continuous force on the brake pedal; do not pump the brake pedal since this will reduce the effectiveness of the ABS and will increase your vehicle's stopping distance. The ABS will be activated immediately, allowing you to retain steering control during hard braking and on slippery surfaces. However, the ABS does not decrease stopping distance.

### **ABS warning lamp**

The ABS lamp in the instrument cluster momentarily illuminates when the ignition is turned on. If the light does not illuminate during start up, remains on or flashes, the ABS may be disabled and may need to be serviced.

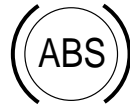

Even when the ABS is disabled, normal braking is still effective. (If your BRAKE warning lamp illuminates with the parking brake released, have your brake system serviced immediately.)

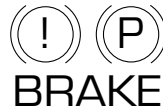

## Driving

### Parking brake

To set the parking brake (1), pull the parking brake handle up as far as possible.

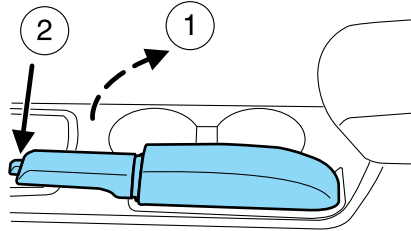

The BRAKE warning lamp will illuminate and will remain illuminated until the parking brake is released.



To release, press and hold the button (2), pull the handle up slightly, then push the handle down.



**WARNING:** Always set the parking brake fully and make sure that the gearshift is securely latched in P (Park) (automatic transmission) or in 1 (First) (manual transmission).



**WARNING:** If the parking brake is fully released, but the brake warning lamp remains illuminated, the brakes may not be working properly. See your authorized dealer as soon as possible.

### TRACTION CONTROL™ (IF EQUIPPED)

Your vehicle may be equipped with a Traction Control™ system. This system helps you maintain the stability and steerability of your vehicle, especially on slippery road surfaces such as snow- or ice-covered roads and gravel roads. The system will allow your vehicle to make better use of available traction in these conditions.

## Driving

 **WARNING:** Aggressive driving in any road conditions can cause you to lose control of your vehicle increasing the risk of severe personal injury or property damage. The occurrence of a Traction Control™ event is an indication that at least some of the tires have exceeded their ability to grip the road; this may lead to an increased risk of loss of vehicle control, vehicle rollover, personal injury and death. If you experience a severe road event, SLOW DOWN.

During Traction Control™ operation, the traction control active light will illuminate, you may hear an electric motor type of sound coming from the engine compartment and the engine will not “rev-up” when you push further on the accelerator. This is normal system behavior and should be no reason for concern.



The Traction Control™ switch is located on the instrument panel. The Traction Control™ system will automatically turn on every time the ignition is turned off and on.

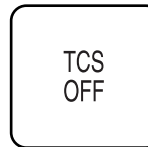



If you should become stuck in snow or ice or on a very slippery road surface, try switching the Traction Control™ system off by pressing the switch. This may allow excess wheel spin to “dig” the vehicle out and enable a successful “rocking” maneuver. If you want to turn off the Traction Control™ system be aware that, for safety reasons, the switch must be pressed and held for at least one second before the system is turned off. To re-engage the Traction Control™ system, the button must again be held for at least one second.



If a system fault is detected, the traction control active light will illuminate, the Traction Control™ button will not turn the system on or off and your vehicle should be serviced by an authorized dealer.

## Driving

### ADVANCETRAC® STABILITY ENHANCEMENT SYSTEM (IF EQUIPPED)

 **WARNING:** Vehicle modifications involving braking system, aftermarket roof racks, suspension, steering system, tire construction and/or wheel/tire size may change the handling characteristics of the vehicle and may adversely affect the performance of the AdvanceTrac® system. In addition, installing any stereo loudspeakers may interfere with and adversely affect the AdvanceTrac® system. Install any aftermarket stereo loudspeaker as far as possible from the front center console, the tunnel, and the front seats in order to minimize the risk of interfering with the AdvanceTrac® sensors. Reducing the effectiveness of the AdvanceTrac® system could lead to an increased risk of loss of vehicle control, vehicle rollover, personal injury and death.

 **WARNING:** Remember that even advanced technology cannot defy the laws of physics. It's always possible to lose control of a vehicle due to inappropriate driver input for the conditions. Aggressive driving on any road condition can cause you to lose control of your vehicle increasing the risk of personal injury or property damage. Activation of the AdvanceTrac® system is an indication that at least some of the tires have exceeded their ability to grip the road; this could reduce the operator's ability to control the vehicle potentially resulting in a loss of vehicle control, vehicle rollover, personal injury and death. If your AdvanceTrac® system activates, SLOW DOWN.

 **WARNING:** If a failure has been detected within the AdvanceTrac® system, the "sliding car" icon  will illuminate steadily. Verify that the AdvanceTrac® system is not manually disabled (push the AdvanceTrac® "Off" button located on the center of the instrument panel). If the "sliding car" icon  still illuminates steadily, have the system service by an authorized dealer immediately.



Your vehicle may be equipped with the AdvanceTrac® system. The AdvanceTrac® system provides the following stability enhancement features for certain driving situations:

- Traction Control (TCS), which functions to help avoid drive-wheel spin and loss of traction.



## Driving

- Electronic Stability Control (ESC), which functions to help avoid skids or lateral slides

The AdvanceTrac® system automatically enables each time the engine is started. All features of the AdvanceTrac® system (TCS and ESC) are active and monitor the vehicle from start-up. However, the system will only intervene if the driving situation requires it.

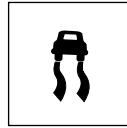
The AdvanceTrac® system includes an AdvanceTrac® "Off" button on the center of the instrument panel, and a "sliding car" icon  in the instrument cluster. The "sliding car" icon  in the instrument cluster



will illuminate temporarily during start-up as part of a normal system self-check, or during driving if a driving situation causes the AdvanceTrac® system to operate. If the "sliding car" icon  illuminates steadily, verify that the AdvanceTrac® system is not manually disabled by pressing the AdvanceTrac® "Off" button located on the center stack of the instrument panel. If the "sliding car" icon  remains steadily illuminated, have the system serviced by an authorized dealer immediately. If equipped with a message center, the vehicle will also indicate a failure with the AdvanceTrac® system.

When AdvanceTrac® performs a normal system self-check, some drivers may notice a slight movement of the brake, and/or a rumble, grunting, or grinding noise after startup and when driving off.

When an event occurs that activates AdvanceTrac® you may experience the following:

- A slight deceleration of the vehicle
- The "sliding car"  indicator light will flash.
- A vibration in the pedal when your foot is on the brake pedal
- If the driving condition is severe and your foot is not on the brake, the brake pedal may move as the systems applies higher brake forces. You may also hear a whoosh of air from under the instrument panel during this severe condition.
- The brake pedal may feel stiffer than usual.

## Driving

### **Traction Control (TCS)**

Traction Control is a driver aid feature that helps your vehicle maintain traction of the wheels, typically when driving on slippery and/or hilly road surfaces, by detecting and controlling wheel spin.

Excessive wheel spin is controlled in two ways, which may work separately or in tandem, Engine Traction Control and Brake Traction Control. Engine Traction Control works to limit drive-wheel spin by momentarily reducing engine power. Brake Traction Control works to limit wheel spin by momentarily applying the brakes to the wheel that is slipping. Traction Control is most active at low speeds.

During Traction Control events the “sliding car” icon  in the instrument cluster will flash.

If the Traction Control system is activated excessively in a short period of time, the braking portion of the system may become temporarily disabled to allow the brakes to cool down. In this situation, Traction Control will use only engine power reduction or transfer to help control the wheels from over-spinning. When the brakes have cooled down, the system will regain all features. Anti-lock braking, and ESC are not affected by this condition and will continue to function during the cool-down period.

The Engine Traction Control and Brake Traction Control system may be deactivated in certain situations. See the *Switching Off AdvanceTrac®* section below.

### **Electronic Stability Control (ESC)**

Electronic Stability Control (ESC) may enhance your vehicle’s directional stability during adverse maneuvers, for example when cornering severely or avoiding objects in the roadway. ESC operates by applying brakes to one or more of the wheels individually and, if necessary, reducing engine power if the system detects that the vehicle is about to skid or slide laterally.

During Electronic Stability Control events the “sliding car” icon  in the instrument cluster will flash.



Certain adverse driving maneuvers may activate the Electronic Stability Control system, which include but are not limited to:

- Taking a turn too fast
- Maneuvering quickly to avoid an accident, pedestrian or obstacle
- Driving over a patch of ice or other slippery surfaces
- Changing lanes on a snow-rutted road

- Entering a snow-free road from a snow-covered side street, or vice versa
- Entering a paved road from a gravel road, or vice versa
- Cornering while towing a heavily loaded trailer (refer to *Trailer towing* in the *Tires, Wheels and Loading* chapter).

### Switching Off AdvanceTrac®

If the vehicle is stuck in snow, mud or sand, and seems to lose engine power, switching off certain features of the AdvanceTrac® system may be beneficial because the wheels are allowed to spin. This will restore full engine power and will enhance momentum through the obstacle. To switch off the AdvanceTrac® system press the AdvanceTrac® "Off" button. Full features of the AdvanceTrac® system can be restored by pressing the AdvanceTrac® "Off" button again or by turning off and restarting the engine.

If you switch off the AdvanceTrac® system, the "sliding car" icon  will illuminate steadily. Pressing the AdvanceTrac® "Off" button again will turn off the lighted button, "sliding car" icon .

In R (Reverse), ABS and the Engine and Brake Traction Control features will continue to function; however, ESC is disabled.

AdvanceTrac® Features			
Button functions	"Sliding car" icon 	ESC	Traction Control
Default at start-up	Illuminated during bulb check	Enabled	Enabled
Button pressed momentarily	Illuminated solid	Enabled	Disabled
Button pressed again after deactivation	Not illuminated	Enabled	Enabled

## Driving

### STEERING

To help prevent damage to the power steering system:

- Never hold the steering wheel at its furthest turning points (until it stops) for more than a few seconds when the engine is running.
- Do not operate the vehicle with a low power steering fluid level (below the MIN mark on the reservoir).
- Some noise is normal during operation. If the noise is excessive, check for a low power steering fluid level before seeking service by your authorized dealer.
- Heavy or uneven steering efforts may be caused by a low power steering fluid level. Check for a low power steering fluid level before seeking service by your authorized dealer.
- Do not fill the power steering fluid reservoir above the MAX mark on the reservoir.

If the power steering system breaks down (or if the engine is turned off), you can steer the vehicle manually, but it takes more effort.

If the steering wanders or pulls, check for:

- an improperly inflated tire
- uneven tire wear
- loose or worn suspension components
- loose or worn steering components
- improper steering alignment

A high crown in the road or high crosswinds may also make the steering seem to wander/pull.



### AUTOMATIC TRANSMISSION OPERATION (IF EQUIPPED)

#### Brake-shift interlock

This vehicle is equipped with a brake-shift interlock feature that prevents the gearshift lever from being moved from P (Park) when the ignition is in the on position unless the brake pedal is depressed.

If you cannot move the gearshift lever out of P (Park) with ignition in the on position and the brake pedal depressed:

1. Apply the parking brake, turn ignition key to off, then remove the key.
2. Insert a tool into the access hole and depress the override; while the override is depressed, move the shift lever to neutral.
3. Start the vehicle.

If it is necessary to use the above procedure to move the gearshift lever, it is possible that a fuse has blown or the vehicle's brakelamps are not operating properly. Refer to *Fuses and relays* in the *Roadside Emergencies* chapter.

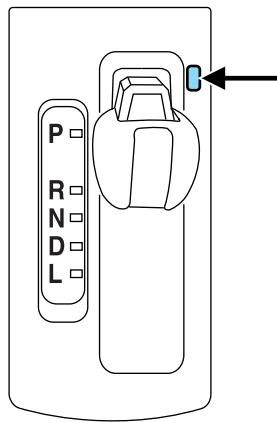

**WARNING:** Do not drive your vehicle until you verify that the brakelamps are working.



**WARNING:** Always set the parking brake fully and make sure the gearshift is latched in P (Park). Turn the ignition to the off position and remove the key whenever you leave your vehicle.



**WARNING:** If the parking brake is fully released, but the brake warning lamp remains illuminated, the brakes may not be working properly. See your authorized dealer.

## Driving

### Understanding the gearshift positions of the 4-speed automatic transmission

This vehicle is equipped with an adaptive Transmission Shift Strategy. Adaptive Shift Strategy offers the optimal transmission operation and shift quality. When the vehicle's battery has been disconnected for any type of service or repair, the transmission will need to relearn the normal shift strategy parameters, much like having to reset your radio stations when your vehicle battery has been disconnected. The Adaptive Transmission Strategy allows the transmission to relearn these operating parameters. This learning process could take several transmission upshifts and downshifts; during this learning process, slightly firmer shifts may occur. After this learning process, normal shift feel and shift scheduling will resume.

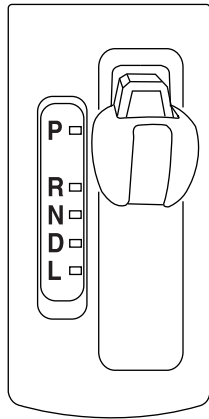

#### **P (Park)**

This position locks the transmission and prevents the front wheels from turning.

To put your vehicle in gear:

- Start the engine
- Depress the brake pedal
- Move the gearshift lever into the desired gear

To put your vehicle in P (Park):

- Come to a complete stop
- Move the gearshift lever and securely latch it in P (Park)

## Driving



**WARNING:** Always set the parking brake fully and make sure the gearshift is latched in P (Park). Turn the ignition to the off position and remove the key whenever you leave your vehicle.

### **R (Reverse)**

With the gearshift lever in R (Reverse), the vehicle will move backward. Always come to a complete stop before shifting into and out of R (Reverse).

### **N (Neutral)**

With the gearshift lever in N (Neutral), the vehicle can be started and is free to roll. Hold the brake pedal down while in this position.

### **D (Drive) with Overdrive**

The normal driving position for the best fuel economy. Transmission operates in gears one through four.

### **D (Drive) without Overdrive**

Overdrive can be deactivated by pressing the transmission control switch on the side of the gearshift lever.

- This position allows for all forward gears (1–3) except overdrive.
- Provides engine braking.
- Use when driving conditions cause excessive shifting from O/D to other gears. Examples: heavy city traffic where continuous shifting in and out of overdrive occurs, hilly terrain, heavy loads, trailer towing and when engine braking is required.
- O/D OFF lamp in the instrument cluster is illuminated.
- To return to O/D (overdrive mode), press the transmission control switch. The O/D OFF lamp in the instrument cluster will not be illuminated.

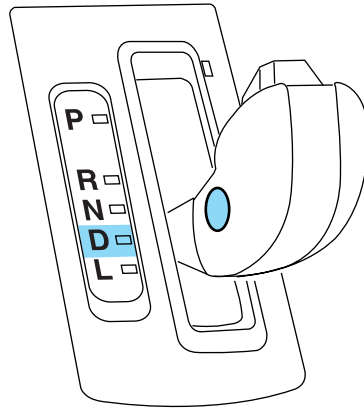

**O/D  
OFF**

## Driving

- O/D (overdrive) is automatically returned each time the key is turned off.

### L (Low)

This position:

- Provides increased engine braking during downhill/mountain driving.
- Provides extended shift scheduling, allowing both upshifts and downshifts, at a higher overall RPM to provide optimum engine braking.
- Is not intended for use under extended or normal driving conditions and results in lower fuel economy.

### If your vehicle gets stuck in mud or snow

If your vehicle gets stuck in mud or snow, it may be rocked out by shifting between forward and reverse gears, stopping between shifts in a steady pattern. Press lightly on the accelerator in each gear.

If necessary, try turning the Traction Control™ system off. This will allow the wheels to spin, which may help to free your stuck vehicle. For more information, refer to *Traction Control™* in this chapter.

**Do not rock the vehicle if the engine is not at normal operating temperature or damage to the transmission may occur.**

**Do not rock the vehicle for more than a minute or damage to the transmission and tires may occur, or the engine may overheat.**

### MANUAL TRANSMISSION OPERATION (IF EQUIPPED)

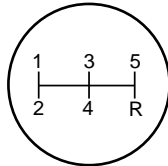

### Using the clutch

Manual transmission vehicles have a starter interlock that prevents cranking the engine unless the clutch pedal is fully depressed.

To start the vehicle:

1. Make sure the parking brake is fully set.

1. Press the clutch pedal to the floor, then put the gearshift lever in the neutral position.

2. Start the engine.

3. Press the brake pedal and move the gearshift lever to the desired gear; 1 (First) or R (Reverse).

4. Release the parking brake, then slowly release the clutch pedal while slowly pressing on the accelerator.

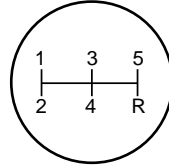

During each shift, the clutch pedal must be fully depressed to the floor. Make sure the floor mat is properly positioned so it doesn't interfere with the full extension of the clutch pedal.

**Failure to fully depress the clutch pedal to the floor may cause increased shift efforts, prematurely wear transmission components or damage the transmission.**

**Do not drive with your foot resting on the clutch pedal or use the clutch pedal to hold your vehicle at a standstill while waiting on a hill. These actions will severely reduce the life of the clutch and could nullify a clutch warranty claim.**

### Recommended shift speeds

**Do not downshift into 1 (First) when your vehicle is moving faster than 15 mph (24 km/h). This will damage the clutch.**

Upshift according to the following chart:

Recommended upshifts (for best fuel economy) when accelerating	
5-speed manual transmission	
Shift from:	
1 - 2	14 mph (23 km/h)
2 - 3	24 mph (39 km/h)
3 - 4	32 mph (51 km/h)
4 - 5	44 mph (71 km/h)

### Reverse

**Make sure that your vehicle is at a complete stop before you shift into R (Reverse). Failure to do so may damage the transmission.**

Hold the clutch pedal down and move the gearshift lever into the neutral position. Wait at least three seconds before shifting into R (Reverse).

## Driving

**Note:** The gearshift lever can only be moved into R (Reverse) by moving it from left of 3 (Third) and 4 (Fourth) before shifting into R (Reverse). This is a lockout feature that protects the transmission from accidentally being shifted into R (Reverse) from 5 (Fifth).

If R (Reverse) is not fully engaged, press the clutch pedal down and return the gearshift to the neutral position. Release the clutch pedal for a moment, then press it down and shift to R (Reverse) again.

### Parking your vehicle

1. Apply the brake and shift into the neutral position.
2. Fully apply the parking brake, then shift into 1 (First).
3. Turn the ignition off.



**WARNING:** Do not park your vehicle in Neutral, it may move unexpectedly and injure someone. Use 1 (First) gear and set the parking brake fully.

### Removing the key

Turn the ignition to position 1 (off) and remove the key.

### DRIVING THROUGH WATER

If driving through deep or standing water is unavoidable, proceed very slowly especially when the depth is not known. Never drive through water that is higher than the bottom of the wheel rims (for cars) or the bottom of the hubs (for trucks).

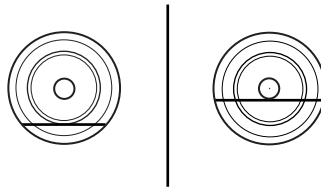

When driving through water, traction or brake capability may be limited. Also, water may enter your engine's air intake and severely damage your engine or your vehicle may stall. **Driving through deep water where the transmission vent tube is submerged may allow water into the transmission and cause internal transmission damage.**

**Once through the water, always dry the brakes by moving your vehicle slowly while applying light pressure on the brake pedal.**

Wet brakes do not stop the vehicle as quickly as dry brakes.

## Roadside Emergencies

### ROADSIDE ASSISTANCE

#### Getting roadside assistance

To fully assist you should you have a vehicle concern, Ford Motor Company offers a complimentary roadside assistance program. This program is separate from the New Vehicle Limited Warranty. The service is available:

- 24-hours, seven days a week
- for the coverage period listed on the Roadside Assistance Card included in your Owner Guide portfolio.

Roadside assistance will cover:

- a flat tire change with a good spare (except vehicles that have been supplied with a tire inflation kit)
- battery jump start
- lock-out assistance (key replacement cost is the customer's responsibility)
- fuel delivery – Independent Service Contractors, if not prohibited by state, local or municipal law shall deliver up to 2.0 gallons (7.5L) of gasoline or 5 gallons (18.9L) of diesel fuel to a disabled vehicle. Fuel delivery service is limited to two no-charge occurrences within a 12-month period.
- winch out – available within 100 feet (30.5 meters) of a paved or county maintained road, no recoveries.
- towing – Ford/Mercury/Lincoln eligible vehicle towed to an authorized dealer within 35 miles (56.3 km) of the disablement location or to the nearest authorized dealer. If a member requests to be towed to an authorized dealer more than 35 miles (56.3 km) from the disablement location, the member shall be responsible for any mileage costs in excess of 35 miles (56.3 km).

Trailers shall be covered up to \$200 if the disabled eligible vehicle requires service at the nearest authorized dealer. If the trailer is disabled, but the towing vehicle is operational, the trailer does not qualify for any roadside services.

## Roadside Emergencies

**Canadian customers refer to your Customer Information Guide for information on:**

- coverage period
- exact fuel amounts
- towing of your disabled vehicle
- emergency travel expense reimbursement
- travel planning benefits

In Canada, for uninterrupted Roadside Assistance coverage, you may purchase extended coverage prior to your Basic Warranty's Roadside Assistance expiring. For more information and enrollment, contact 1-877-294-2582 or visit our website at [www.ford.ca](http://www.ford.ca).

### Using roadside assistance

Complete the roadside assistance identification card and place it in your wallet for quick reference. In the United States, this card is found in the Owner Guide portfolio in the glove compartment. In Canada, the card is found in the *Customer Information Guide* in the glove compartment.

U.S. Ford, Mercury and Lincoln vehicle customers who require Roadside Assistance, call 1-800-241-3673.

Canadian customers who require roadside assistance, call 1-800-665-2006.

If you need to arrange roadside assistance for yourself, Ford Motor Company will reimburse a reasonable amount for towing to the nearest dealership within 35 miles. To obtain reimbursement information, U.S. Ford, Mercury and Lincoln vehicle customers call 1-800-241-3673. Customers will be asked to submit their original receipts.

Canadian customers who need to obtain reimbursement information, call 1-800-665-2006.



## Roadside Emergencies

### HAZARD FLASHER CONTROL

The hazard flasher is located on the steering column, just behind the steering wheel. The hazard flashers will operate when the ignition is in any position or if the key is not in the ignition.

Push in the flasher control and all front and rear direction signals will flash. Press the flasher control again to turn them off. Use it when your vehicle is disabled and is creating a safety hazard for other motorists.

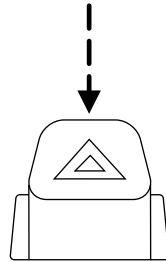

**Note:** With extended use, the flasher may run down your battery.

### FUEL PUMP SHUT-OFF SWITCH

This device stops the electric fuel pump from sending fuel to the engine when your vehicle has had a substantial jolt.

After an accident, if the engine cranks but does not start, this switch may have been activated.

This switch is located in the front passenger's footwell, behind the kick panel access cover.

To reset the switch:

1. Turn the ignition off.
2. Check the fuel system for leaks.
3. If no leaks are apparent, reset the switch by pushing in on the reset button.
4. Turn the ignition to the on position.
5. Wait a few seconds and return the key to off.
6. Make another check for leaks.

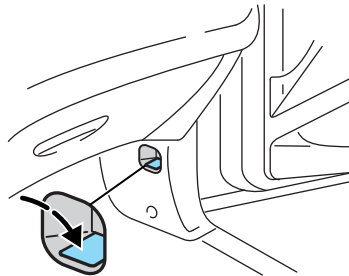

## Roadside Emergencies

### FUSES AND RELAYS

#### Fuses

If electrical components in the vehicle are not working, a fuse may have blown. Blown fuses are identified by a broken wire within the fuse. Check the appropriate fuses before replacing any electrical components.

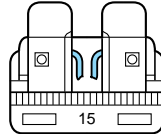

**Note:** Always replace a fuse with one that has the specified amperage rating. Using a fuse with a higher amperage rating can cause severe wire damage and could start a fire.

#### Standard fuse amperage rating and color

COLOR					
Fuse rating	Mini fuses	Standard fuses	Maxi fuses	Cartridge maxi fuses	Fuse link cartridge
2A	Grey	Grey	—	—	—
3A	Violet	Violet	—	—	—
4A	Pink	Pink	—	—	—
5A	Tan	Tan	—	—	—
7.5A	Brown	Brown	—	—	—
10A	Red	Red	—	—	—
15A	Blue	Blue	—	—	—
20A	Yellow	Yellow	Yellow	Blue	Blue
25A	Natural	Natural	—	—	—
30A	Green	Green	Green	Pink	Pink
40A	—	—	Orange	Green	Green
50A	—	—	Red	Red	Red
60A	—	—	Blue	Yellow	Yellow
70A	—	—	Tan	—	Brown
80A	—	—	Natural	Black	Black

## Roadside Emergencies

### Passenger compartment fuse panel

The fuse panel is located below and to the left of the steering wheel by the brake pedal. Remove the fuse panel cover to gain access to the fuses.

To remove a fuse use the fuse puller tool provided on the fuse panel cover.

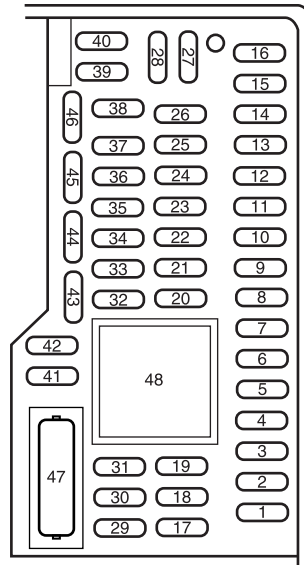

The fuses are coded as follows.

Fuse/Relay Location	Fuse Amp Rating	Protected circuits
1	30A	Not used (spare)
2	15A	Brake Switch CHMSL
3	15A	Satellite radio
4	30A	Not used (spare)
5	10A	Shift Interlock
6	20A	Right Front Turn lamp/Left Front Turn lamp, Rear stop/turn lamps

## Roadside Emergencies

Fuse/Relay Location	Fuse Amp Rating	Protected circuits
7	10A	Left Low beam Headlamp
8	10A	Right Low beam Headlamp
9	15A	Interior Lamps
10	15A	Instrument Panel Backlighting
11	10A	Not used (spare)
12	7.5A	Power Mirrors
13	5A	SYNC
14	10A	Not used (spare)
15	10A	Recirculated Air, Air Conditioning
16	15A	Not used (spare)
17	20A	Power Locks, Trunk Release
18	20A	Heated Seats
19	25A	Not used (spare)
20	15A	Data Link Connector
21	15A	Fog lamps, Fog lamp Indicator
22	15A	Parking Lamps
23	15A	High Beam Lamps
24	20A	Horn
25	10A	Demand Lamps, Trunk Lamps
26	10A	Instrument Cluster
27	20A	Ignition Switch
28	5A	Radio (Start)
29	5A	Instrument Cluster (Run/Start)
30	5A	Not used (spare)
31	10A	ABS
32	10A	Restraints Control Module
33	10A	Not used (spare)
34	5A	Not used (spare)
35	10A	Not used (spare)
36	5A	PATS Module
37	10A	Climate Control (Run/Start)

## Roadside Emergencies

Fuse/Relay Location	Fuse Amp Rating	Protected circuits
38	20A	Subwoofer
39	20A	Radio/CID/EFP
40	20A	Not used (spare)
41	15A	Door Lock/sunroof switch illumination, Electrochromic mirror, Ambient lighting
42	10A	Not used (spare)
43	10A	Not used (spare)
44	10A	Not used (spare)
45	5A	Front Wipers (logic)
46	7.5A	Front Passenger Sensing System
47	30A (circuit breaker)	Sunroof, Power Windows
48	—	Delayed accessory relay

### Power distribution box

The power distribution box is located in the engine compartment. The power distribution box contains high-current fuses that protect your vehicle's main electrical systems from overloads.



**WARNING:** Always disconnect the battery before servicing high current fuses.



**WARNING:** To reduce risk of electrical shock, always replace the cover to the Power Distribution Box before reconnecting the battery or refilling fluid reservoirs.

If the battery has been disconnected and reconnected, refer to the *Battery* section of the *Maintenance and Specifications* chapter.

## Roadside Emergencies

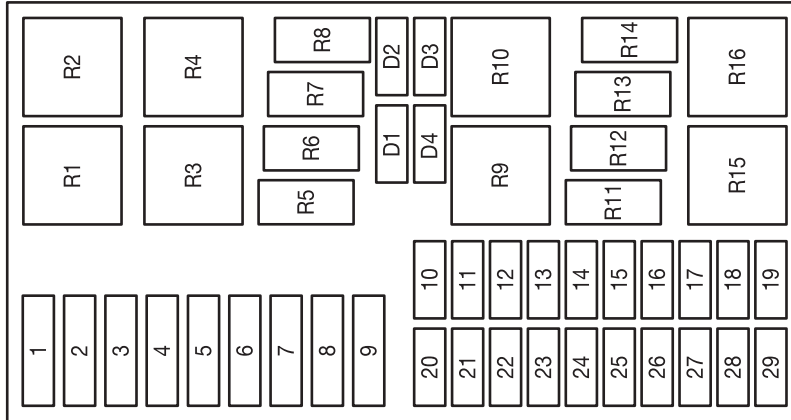

To remove a fuse, use the fuse puller tool provided on the inside of the passenger compartment fuse panel cover.

The high-current fuses are coded as follows:

Fuse/Relay Location	Fuse Amp Rating	Protected circuits
1	15A	Heated mirror
2	30A	Rear defrost
3	20A	Power point
4	20A	Fuel pump
5	10A	Powertrain control module (PCM) KAPWR / Canister Vent
6	15A	Alt sense
7	10A	Reverse lamps
8	—	Not used
9	40A	ABS motor
10	30A	Wipers
11	30A	Starter
12	40A	Blower
13	10A	A/C clutch

## Roadside Emergencies

Fuse/Relay Location	Fuse Amp Rating	Protected circuits
14	10A	PCM relay coil
15	20A	Front power point
16	20A	Cooling fan—low
17	30A	Cooling fan—high
18	20A	ABS solenoid
19	—	Not used
20	—	A/C clutch relay
21A	—	Rear defrost relay
21B	—	Not used
21C	—	Blower relay
21D	—	PCM relay
22	10A	Fuel injector
23	—	Not used
24	—	Not used
25	—	Not used
26	15A	PCM MIL
27	—	Not used
28	15A	PCM
29	15A	Ignition
30A	—	Cooling fan low speed relay
30B	—	Starter relay
30C	—	Not used
30D	—	Cooling fan high speed relay
31A	—	Reverse lamp relay
31B	—	Fuel pump relay
31C	—	Wiper power relay
31D	—	Not used
31E	—	Not used
31F	—	Not used
32	—	A/C clutch diode
33	—	EEC diode
34	—	One Touch Integrated Start (OTIS) diode
35	10A	Run/Start

## Roadside Emergencies

### CHANGING A FLAT TIRE

If you get a flat tire while driving:

- do not brake heavily.
- gradually decrease the vehicle's speed.
- hold the steering wheel firmly.
- slowly move to a safe place on the side of the road.

Your vehicle may be equipped with a conventional spare tire that is different in one or more of the following: type, brand, size, speed rating and tread design. If this is the case, this dissimilar spare tire is still rated for your vehicle loads (GAWR and GVWR). This temporary spare tire is not equipped with a tire pressure monitoring system (TPMS) sensor.

**Note:** The tire pressure monitoring system (TPMS) indicator light will illuminate when the spare is in use. To restore the full functionality of the TPMS system, all road wheels equipped with the tire pressure monitoring sensors must be mounted on the vehicle.

Have a flat tire serviced by an authorized dealer in order to prevent damage to the TPMS sensor, refer to *Tire Pressure Monitoring System (TPMS)* in the *Tires, Wheels, and Loading* chapter. Replace the spare tire with a road tire as soon as possible. During repairing or replacing of the flat tire, have the authorized dealer inspect the TPMS sensor for damage.



**WARNING:** The use of tire sealants may damage your Tire Pressure Monitoring System and should not be used.



**WARNING:** Refer to *Tire Pressure Monitoring System (TPMS)* in the *Tire, Wheels and Loading* chapter for important information. If the tire pressure monitor sensor becomes damaged, it will no longer function.

### Dissimilar spare tire/wheel information



**WARNING:** Failure to follow these guidelines could result in an increased risk of loss of vehicle control, injury or death.

If you have a dissimilar spare tire/wheel, then it is intended for temporary use only. This means that if you need to use it, you should replace it as soon as possible with a road tire/wheel that is the same size



## Roadside Emergencies

and type as the road tires and wheels that were originally provided by Ford. If the dissimilar spare tire or wheel is damaged, it should be replaced rather than repaired.

A dissimilar spare tire/wheel is defined as a spare tire and/or wheel that is different in brand, size or appearance from the road tires and wheels and can be one of three types:

1. **T-type mini-spare:** This spare tire begins with the letter “T” for tire size and may have “Temporary Use Only” molded in the sidewall
2. **Full-size dissimilar spare with label on wheel:** This spare tire has a label on the wheel that states: “THIS TIRE AND WHEEL FOR TEMPORARY USE ONLY”

When driving with one of the dissimilar spare tires listed above, **do not:**

- Exceed 50 mph (80 km/h)
- Load the vehicle beyond maximum vehicle load rating listed on the Safety Compliance Label
- Tow a trailer
- Use snow chains on the end of the vehicle with the dissimilar spare tire
- Use more than one dissimilar spare tire at a time
- Use commercial car washing equipment
- Try to repair the dissimilar spare tire

Use of one of the dissimilar spare tires listed above at any one wheel location can lead to impairment of the following:

- Handling, stability and braking performance
- Comfort and noise
- Ground clearance and parking at curbs
- Winter weather driving capability
- Wet weather driving capability

### 3. **Full-size dissimilar spare without label on wheel**

When driving with the full-size dissimilar spare tire/wheel, **do not:**

- Exceed 70 mph (113 km/h)
- Use more than one dissimilar spare tire/wheel at a time
- Use commercial car washing equipment
- Use snow chains on the end of the vehicle with the dissimilar spare tire/wheel

## Roadside Emergencies

The usage of a full-size dissimilar spare tire/wheel can lead to impairment of the following:

- Handling, stability and braking performance
- Comfort and noise
- Ground clearance and parking at curbs
- Winter weather driving capability
- Wet weather driving capability
- All-Wheel driving capability (if applicable)
- Load leveling adjustment (if applicable)

When driving with the full-size dissimilar spare tire/wheel additional caution should be given to:

- Towing a trailer
- Driving vehicles equipped with a camper body
- Driving vehicles with a load on the cargo rack

Drive cautiously when using a full-size dissimilar spare tire/wheel and seek service as soon as possible.

### Stopping and securing the vehicle

1. Park on a level surface, set the parking brake and activate the hazard flashers.

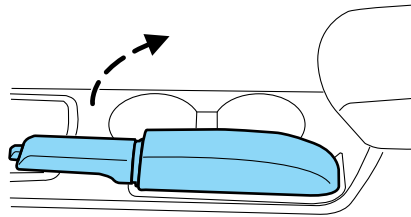

2. Place the gearshift lever in P (Park) (automatic transmission) or R (Reverse) (manual transmission) and turn the engine off.

### Tire change procedure



**WARNING:** When one of the front wheels is off the ground, the transmission alone will not prevent the vehicle from moving or slipping off the jack, even if the vehicle is in P (Park) (automatic transmission) or R (Reverse) (manual transmission).

## Roadside Emergencies

 **WARNING:** To help prevent the vehicle from moving when you change a tire, be sure the parking brake is set, then block (in both directions) the wheel that is diagonally opposite (other side and end of the vehicle) to the tire being changed.

 **WARNING:** If the vehicle slips off the jack, you or someone else could be seriously injured.

 **WARNING:** Do not attempt to change a tire on the side of the vehicle close to moving traffic. Pull far enough off the road to avoid the danger of being hit when operating the jack or changing the wheel.

1. Remove the spare tire and jack by turning their tie-down bolts counterclockwise. The lug wrench is located in a bag next to, or on top of, the spare tire.

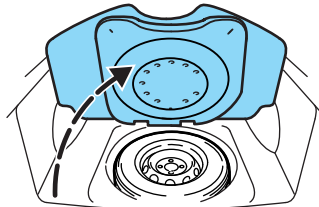

2. Block the diagonally opposite wheel.

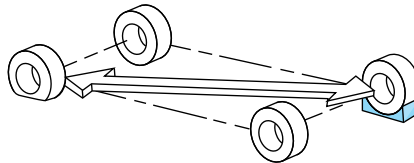

3. If equipped with a 6-spoke wheel cover that's bolted on, remove the four plastic nuts by turning counterclockwise 1/4 turn for access to the lug nuts.

**Note:** To avoid damage to the wheel cover, the 6-spoke wheel cover cannot be removed until the tire is off the vehicle.

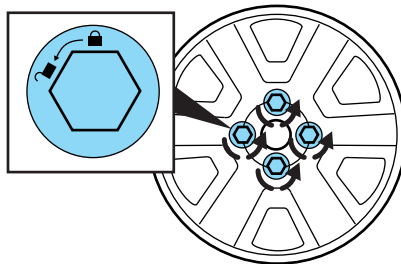

## Roadside Emergencies

4. Loosen each wheel lug nut one-half turn counterclockwise but do not remove them until the wheel is raised off the ground.

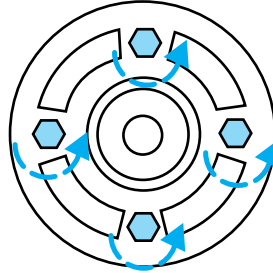

5. The vehicle jacking points are depicted on the yellow warning label on the jack shown here (2-door model shown, 4-door model similar). Depending on which tire is to be changed, put the jack approximately 7 inches (18 cm) from the front wheel opening (1) or approximately 17 inches (43 cm) from the rear wheel opening (2).

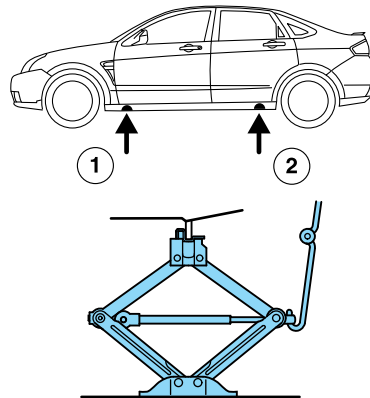

**Jack at the specified locations to avoid damage to the vehicle.**

**!** **WARNING:** To lessen the risk of personal injury, do not put any part of your body under the vehicle while changing a tire. Do not start the engine when your vehicle is on the jack. The jack is only meant for changing the tire.

6. Remove the lug nuts with the lug wrench.

7. Replace the flat tire with the spare tire, making sure the valve stem is facing outward. Reinstall the lug nuts until the wheel is snug against the hub. Do not fully tighten the lug nuts until the wheel has been lowered.

8. Lower the wheel by turning the jack handle counterclockwise.

## Roadside Emergencies

9. Remove the jack and fully tighten the lug nuts in the order shown. Refer to *Wheel lug nut torque specifications* later in this chapter for the proper lug nut torque specification.

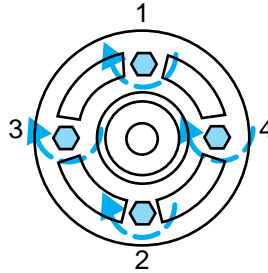

10. Put the flat tire, jack and lug wrench away. Make sure the jack is fastened so it does not rattle when you drive. Unblock the wheels.

### WHEEL LUG NUT TORQUE SPECIFICATIONS

Retighten the lug nuts to the specified torque at 500 miles (800 km) after any wheel disturbance (tire rotation, changing a flat tire, wheel removal, etc.).

Bolt size	Wheel lug nut torque*	
	lb. ft.	N•m
M12 x 1.5	100	135

\* Torque specifications are for nut and bolt threads free of dirt and rust. Use only Ford recommended replacement fasteners.

**!** **WARNING:** When a wheel is installed, always remove any corrosion, dirt or foreign materials present on the mounting surfaces of the wheel or the surface of the wheel hub, brake drum or brake disc that contacts the wheel. Ensure that any fasteners that attach the rotor to the hub are secured so they do not interfere with the mounting surfaces of the wheel. Installing wheels without correct metal-to-metal contact at the wheel mounting surfaces can cause the wheel nuts to loosen and the wheel to come off while the vehicle is in motion, resulting in loss of control.

## Roadside Emergencies

**Note:** Inspect the wheel pilot hole prior to installation. If there is visible corrosion in wheel pilot hole, remove loose particles by wiping with clean rag and apply grease. Apply grease only to the wheel pilot hole surface by smearing a “dime” (1 square cm) sized glob of grease around the wheel pilot surface (1) with end of finger. **DO NOT** apply grease to lugnut/stud holes or wheel-to-brake surfaces.

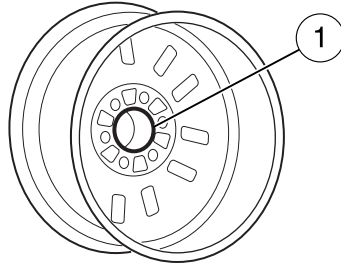

### JUMP STARTING



**WARNING:** The gases around the battery can explode if exposed to flames, sparks, or lit cigarettes. An explosion could result in injury or vehicle damage.



**WARNING:** Batteries contain sulfuric acid which can burn skin, eyes and clothing, if contacted.

**Do not attempt to push-start your automatic transmission vehicle. Automatic transmissions do not have push-start capability. Attempting to push-start a vehicle with an automatic transmission may cause transmission damage.**

### Preparing your vehicle

When the battery is disconnected or a new battery is installed, the automatic transmission must relearn its shift strategy. As a result, the transmission may have firm and/or soft shifts. This operation is considered normal and will not affect function or durability of the transmission. Over time, the adaptive learning process will fully update transmission operation.

1. **Use only a 12-volt supply to start your vehicle.**
2. Do not disconnect the battery of the disabled vehicle as this could damage the vehicle's electrical system.
3. Park the booster vehicle close to the hood of the disabled vehicle making sure the two vehicles **do not** touch. Set the parking brake on both vehicles and stay clear of the engine cooling fan and other moving parts.

## Roadside Emergencies

4. Check all battery terminals and remove any excessive corrosion before you attach the battery cables. Ensure that vent caps are tight and level.
5. Turn the heater fan on in both vehicles to protect from any electrical surges. Turn all other accessories off.

### Connecting the jumper cables

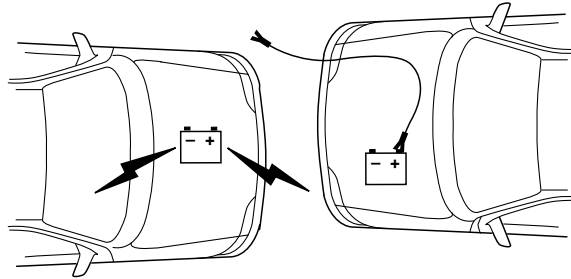

1. Connect the positive (+) jumper cable to the positive (+) terminal of the discharged battery.

**Note:** In the illustrations, *lightning bolts* are used to designate the assisting (boosting) battery.

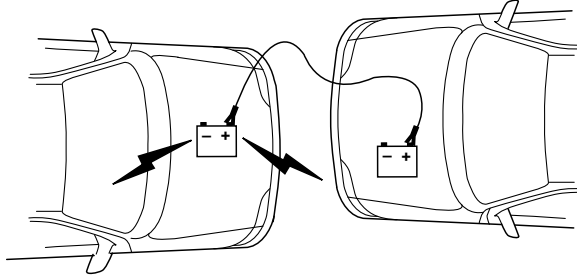

2. Connect the other end of the positive (+) cable to the positive (+) terminal of the assisting battery.

## Roadside Emergencies

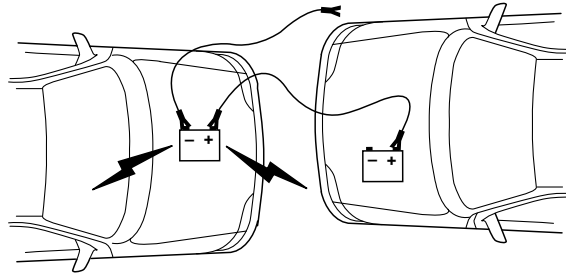

3. Connect the negative (-) cable to the negative (-) terminal of the assisting battery.

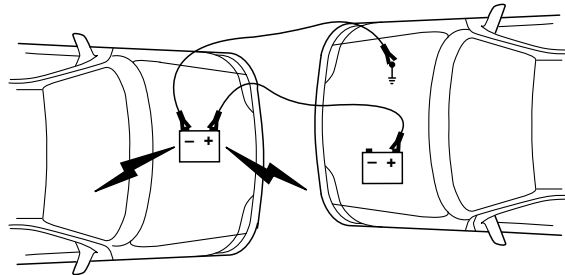

4. Make the final connection of the negative (-) cable to an exposed metal part of the stalled vehicle's engine, away from the battery and the carburetor/fuel injection system. **Do not** use fuel lines, engine rocker covers or the intake manifold as *grounding* points.

 **WARNING:** Do not connect the end of the second cable to the negative (-) terminal of the battery to be jumped. A spark may cause an explosion of the gases that surround the battery.

5. Ensure that the cables are clear of fan blades, belts, moving parts of both engines, or any fuel delivery system parts.



## Roadside Emergencies

### Jump starting

1. Start the engine of the booster vehicle and run the engine at moderately increased speed.
2. Start the engine of the disabled vehicle.
3. Once the disabled vehicle has been started, run both engines for an additional three minutes before disconnecting the jumper cables.

### Removing the jumper cables

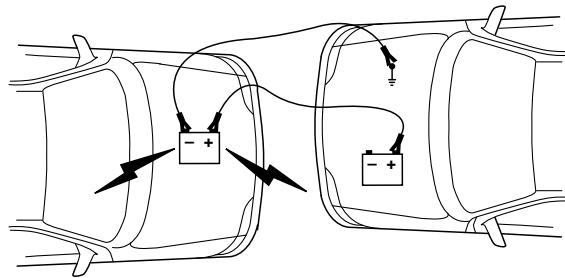

**Remove the jumper cables in the reverse order that they were connected.**

1. Remove the jumper cable from the *ground* metal surface.

**Note:** In the illustrations, *lightning bolts* are used to designate the assisting (boosting) battery.

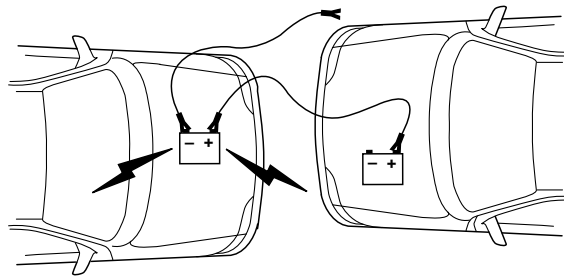

2. Remove the jumper cable on the negative (-) connection of the booster vehicle's battery.

## Roadside Emergencies

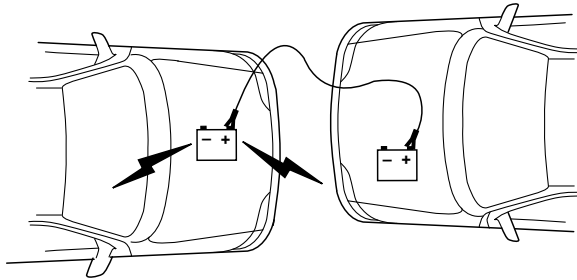

3. Remove the jumper cable from the positive (+) terminal of the booster vehicle's battery.

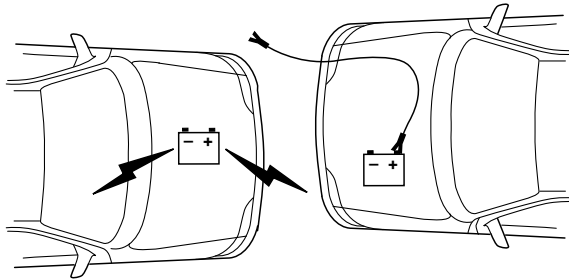

4. Remove the jumper cable from the positive (+) terminal of the disabled vehicle's battery.

After the disabled vehicle has been started and the jumper cables removed, allow it to idle for several minutes so the engine computer can *relearn* its idle conditions.

## Roadside Emergencies

### WRECKER TOWING

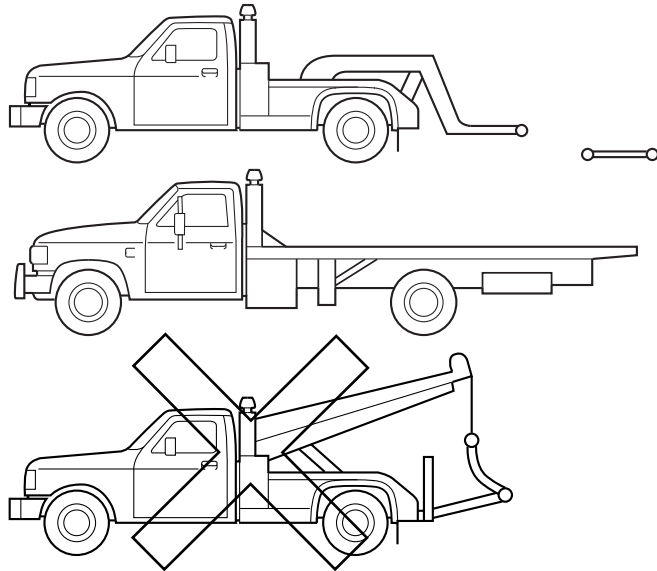

If you need to have your vehicle towed, contact a professional towing service or, if you are a member of a roadside assistance program, your roadside assistance service provider.

It is recommended that your vehicle be towed with a wheel lift or flatbed equipment. Do not tow with a slingbelt. Ford Motor Company has not approved a slingbelt towing procedure.

If your vehicle is to be towed from the rear using wheel lift equipment, the front wheels (drive wheels) must be placed on a dolly to prevent damage to the transmission.

**If the vehicle is towed by other means or incorrectly, vehicle damage may occur.**

Ford Motor Company produces a towing manual for all authorized tow truck operators. Have your tow truck operator refer to this manual for proper hook-up and towing procedures for your vehicle.

## Roadside Emergencies

### Emergency towing

In case of a roadside emergency with a disabled vehicle (without access to wheel dollies, car hauling trailer, or flatbed transport vehicle) your vehicle (regardless of transmission powertrain configuration) can be flat towed (all wheels on the ground) under the following conditions:

- Vehicle is facing forward so that it is being towed in a forward direction.
- Place the transmission in N (Neutral). Refer to *Brake shift interlock* in the *Driving* chapter for specific instructions if you cannot move the gear shift lever into N (Neutral).
- Maximum speed is not to exceed 35 mph (56 km/h).
- Maximum distance is 50 miles (80 km).

## Customer Assistance

### GETTING THE SERVICES YOU NEED

Warranty repairs to your vehicle must be performed by an authorized Ford, Lincoln, or Mercury dealer. While any authorized dealer handling your vehicle line will provide warranty service, we recommend you return to your selling authorized dealer who wants to ensure your continued satisfaction.

Please note that certain warranty repairs require special training and/or equipment, so not all authorized dealers are authorized to perform all warranty repairs. This means that, depending on the warranty repair needed, you may have to take your vehicle to another authorized dealer.

A reasonable time must be allowed to perform a repair after taking your vehicle to the authorized dealer. Repairs will be made using Ford or Motorcraft parts, or remanufactured or other parts that are authorized by Ford.

### Away from home

If you are away from home when your vehicle needs service, contact the Ford Customer Relationship Center or use the online resources listed below to find the nearest authorized dealer.

In the United States:

#### Mailing Address

Ford Motor Company  
Customer Relationship Center  
P.O. Box 6248  
Dearborn, MI 48121

#### Telephone

1-800-392-3673 (FORD)  
(TDD for the hearing impaired: 1-800-232-5952)

#### Online

Additional information and resources are available online at [www.genuineservice.com](http://www.genuineservice.com).

- U.S. dealer locator by Dealer Name, City/State, or Zip Code
- Owner Guides
- Maintenance Schedules
- Recalls
- Ford Extended Service Plans
- Ford Genuine Accessories
- Service specials and promotions.

## Customer Assistance

In Canada:

### **Mailing Address (Ford vehicles)**

Customer Relationship Centre  
Ford Motor Company of Canada, Limited  
P.O. Box 2000  
Oakville, Ontario L6J 5E4

### **Telephone**

1-800-565-3673 (FORD)

### **Online**

[www.ford.ca](http://www.ford.ca)

### **Mailing Address (Lincoln vehicles)**

Lincoln Centre  
Ford Motor Company of Canada, Limited  
P.O. Box 2000  
Oakville, Ontario L6J 5E4

### **Telephone**

1-800-387-9333

### **Online**

[www.lincolncanada.com](http://www.lincolncanada.com)

### **Additional Assistance**

If you have questions or concerns, or are unsatisfied with the service you are receiving, follow these steps:

1. Contact your Sales Representative or Service Advisor at your selling/servicing authorized dealer.
2. If your inquiry or concern remains unresolved, contact the Sales Manager, Service Manager or Customer Relations Manager.
3. If you require assistance or clarification on Ford Motor Company policies, please contact the Ford Customer Relationship Center

In order to help you serve you better, please have the following information available when contacting a Customer Relationship Center:

- Vehicle Identification Number (VIN)
- Your telephone number (home and business)
- The name of the authorized dealer and city where located
- The vehicle's current odometer reading

In some states, you must directly notify Ford in writing before pursuing remedies under your state's warranty laws. Ford is also allowed a final repair attempt in some states.

206

<https://www.MyCarManual.com>

## Customer Assistance

In the United States, a warranty dispute must be submitted to the BBB AUTO LINE before taking action under the Magnuson-Moss Warranty Act, or to the extent allowed by state law, before pursuing replacement or repurchase remedies provided by certain state laws. This dispute handling procedure is not required prior to enforcing state created rights or other rights which are independent of the Magnuson-Moss Warranty Act or state replacement or repurchase laws.

### **IN CALIFORNIA (U.S. ONLY)**

California Civil Code Section 1793.2(d) requires that, if a manufacturer or its representative is unable to repair a motor vehicle to conform to the vehicle's applicable express warranty after a reasonable number of attempts, the manufacturer shall be required to either replace the vehicle with one substantially identical or repurchase the vehicle and reimburse the buyer in an amount equal to the actual price paid or payable by the consumer (less a reasonable allowance for consumer use). The consumer has the right to choose whether to receive a refund or replacement vehicle.

California Civil Code Section 1793.22(b) presumes that the manufacturer has had a reasonable number of attempts to conform the vehicle to its applicable express warranties if, within the first 18 months of ownership of a new vehicle or the first 18,000 miles (29,000 km), whichever occurs first:

1. Two or more repair attempts are made on the same non-conformity likely to cause death or serious bodily injury OR
2. Four or more repair attempts are made on the same nonconformity (a defect or condition that substantially impairs the use, value or safety of the vehicle) OR
3. The vehicle is out of service for repair of nonconformities for a total of more than 30 calendar days (not necessarily all at one time)

In the case of 1 or 2 above, the consumer must also notify the manufacturer of the need for the repair of the nonconformity at the following address:

Ford Motor Company  
16800 Executive Plaza Drive  
Mail Drop 3NE-B  
Dearborn, MI 48126

## Customer Assistance

### **THE BETTER BUSINESS BUREAU (BBB) AUTO LINE PROGRAM (U.S. ONLY)**

Your satisfaction is important to Ford Motor Company and to your dealer. If a warranty concern has not been resolved using the three-step procedure outlined on the first page of the *Customer Assistance* section, you may be eligible to participate in the BBB AUTO LINE program.

The BBB AUTO LINE program consists of two parts – mediation and arbitration. During mediation, a representative of the BBB will contact both you and Ford Motor Company to explore options for settlement of the claim. If an agreement is not reached during mediation and your claim is eligible, you may participate in the arbitration process. An arbitration hearing will be scheduled so that you can present your case in an informal setting before an impartial person. The arbitrator will consider the testimony provided and make a decision after the hearing.

You are not bound by the decision, but should you choose to accept the BBB AUTO LINE decision, Ford must abide by the accepted decision as well. Disputes submitted to the BBB AUTO LINE program are usually decided within forty days after you file your claim with the BBB.

BBB AUTO LINE Application: Using the information provided below, please call or write to request a program application. You will be asked for your name and address, general information about your new vehicle, information about your warranty concerns, and any steps you have already taken to try to resolve them. A Customer Claim Form will be mailed that will need to be completed, signed and returned to the BBB along with proof of ownership. Upon receipt, the BBB will review the claim for eligibility under the Program Summary Guidelines.

**You can get more information by calling BBB AUTO LINE at 1-800-955-5100, or writing to:**

**BBB AUTO LINE  
4200 Wilson Boulevard, Suite 800  
Arlington, Virginia 22203-1833**

BBB AUTO LINE applications can also be requested by calling the Ford Motor Company Customer Relationship Center at 1-800-392-3673.

**Note:** Ford Motor Company reserves the right to change eligibility limitations, modify procedures, or to discontinue this process at any time without notice and without obligation.



## Customer Assistance

### **UTILIZING THE MEDIATION/ARBITRATION PROGRAM (CANADA ONLY)**

For vehicles delivered to authorized Canadian dealers. In those cases where you continue to feel that the efforts by Ford of Canada and the authorized dealer to resolve a factory-related vehicle service concern have been unsatisfactory, Ford of Canada participates in an impartial third party mediation/arbitration program administered by the Canadian Motor Vehicle Arbitration Plan (CAMVAP).

The CAMVAP program is a straight-forward and relatively speedy alternative to resolve a disagreement when all other efforts to produce a settlement have failed. This procedure is without cost to you and is designed to eliminate the need for lengthy and expensive legal proceedings.

In the CAMVAP program, impartial third-party arbitrators conduct hearings at mutually convenient times and places in an informal environment. These impartial arbitrators review the positions of the parties, make decisions and, when appropriate, render awards to resolve disputes. CAMVAP decisions are fast, fair, and final as the arbitrator's award is binding both to you and Ford of Canada.

CAMVAP services are available in all territories and provinces. For more information, without charge or obligation, call your CAMVAP Provincial Administrator directly at 1-800-207-0685.

### **FORD EXTENDED SERVICE PLAN**

You can get more protection for your new car or light truck by purchasing Ford Extended Service Plan (Ford ESP) coverage. It provides the following:

- Benefits during the warranty period depending on the plan you purchase (such as: reimbursement for rentals; coverage for certain maintenance and wear items).
- Protection against covered repair costs after your Bumper-to-Bumper Warranty expires.

You may purchase Ford ESP from any participating authorized dealer. There are several plans available in various time, distance and deductible combinations which can be tailored to fit your own driving needs. Ford ESP also offers reimbursement benefits for towing and rental coverage.

When you buy Ford ESP, you receive Peace-of-Mind protection throughout the United States and Canada, provided by a network of more than 4,600 participating authorized dealers.

## Customer Assistance

If you did not take advantage of the Ford Extended Service Plan at the time of purchasing your vehicle, you may still be eligible. Since this information is subject to change, please ask your authorized dealer for complete details about Ford Extended Service Plan coverage options, or visit the Ford ESP website at [www.ford-esp.com](http://www.ford-esp.com).

### GETTING ASSISTANCE OUTSIDE THE U.S. AND CANADA

Before exporting your vehicle to a foreign country, contact the appropriate foreign embassy or consulate. These officials can inform you of local vehicle registration regulations and where to find unleaded fuel.

If you cannot find unleaded fuel or can only get fuel with an anti-knock index lower than is recommended for your vehicle, contact a regional office or owner relations/customer relationship office.

The use of leaded fuel in your vehicle without proper conversion may damage the effectiveness of your emission control system and may cause engine knocking or serious engine damage. Ford Motor Company/Ford of Canada is not responsible for any damage caused by use of improper fuel. Using leaded fuel may also result in difficulty importing your vehicle back into the U.S.

If your vehicle must be serviced while you are traveling or living in Central America, the Caribbean, or the Middle East, contact the nearest authorized dealer. If the authorized dealer cannot help you, contact:

FORD MOTOR COMPANY  
FORD EXPORT OPERATIONS  
1555 Fairlane Drive  
Fairlane Business Park #3  
Allen Park, Michigan 48101  
U.S.A.  
Telephone: (313) 594-4857  
FAX: (313) 390-0804  
Email: [expcac@ford.com](mailto:expcac@ford.com)

If you are in another foreign country, contact the nearest authorized dealer. If the authorized dealer employees cannot help you, they can direct you to the nearest Ford affiliate office.

If you buy your vehicle in North America and then relocate outside of the U.S. or Canada, register your vehicle identification number (VIN) and new address with Ford Motor Company Export Operations.

**Customers in the U.S. should call 1-800-392-3673.**

## Customer Assistance

### ORDERING ADDITIONAL OWNER'S LITERATURE

To order the publications in this portfolio, contact Helm, Incorporated at:

HELM, INCORPORATED  
P.O. Box 07150  
Detroit, Michigan 48207

Or to order a free publication catalog, call toll free: 1-800-782-4356

Monday-Friday 8:00 a.m. - 6:00 p.m. EST

Helm, Incorporated can also be reached by their website:  
[www.helminc.com](http://www.helminc.com).

*(Items in this catalog may be purchased by credit card, check or money order.)*

### Obtaining a French owner's guide

French Owner's Guides can be obtained from your authorized dealer or by writing to:

Ford Motor Company of Canada, Limited  
Service Publications CHQ202  
The Canadian Road  
P.O. Box 2000  
Oakville, ON, Canada  
L6J 5E4

### REPORTING SAFETY DEFECTS (U.S. ONLY)

If you believe that your vehicle has a defect which could cause a crash or could cause injury or death, you should immediately inform the National Highway Traffic Safety Administration (NHTSA) in addition to notifying Ford Motor Company.



If NHTSA receives similar complaints, it may open an investigation, and if it finds that a safety defect exists in a group of vehicles, it may order a recall and remedy campaign. However, NHTSA cannot become involved in individual problems between you, your dealer, or Ford Motor Company.

## Customer Assistance

To contact NHTSA, you may call the Vehicle Safety Hotline toll-free at 1-888-327-4236 (TTY: 1-800-424-9153); go to <http://www.safercar.gov>; or write to:

Administrator  
1200 New Jersey Avenue, Southeast  
Washington, D.C. 20590

You can also obtain other information about motor vehicle safety from <http://www.safercar.gov>.

### **REPORTING SAFETY DEFECTS (CANADA ONLY)**

If you believe that your vehicle has a defect which could cause a crash or could cause injury or death, you should immediately inform Transport Canada, using their toll-free number: 1-800-333-0510.

### WASHING THE EXTERIOR

Wash your vehicle regularly with cool or lukewarm water and a neutral pH shampoo, such as Motorcraft Detail Wash (ZC-3-A), which is available from your authorized dealer.

- Never use strong household detergents or soap, such as dish washing or laundry liquid. These products can discolor and spot painted surfaces.
- Never wash a vehicle that is “hot to the touch” or during exposure to strong, direct sunlight.
- Always use a clean sponge or car wash mitt with plenty of water for best results.
- Dry the vehicle with a chamois or soft terry cloth towel in order to eliminate water spotting.
- It is especially important to wash the vehicle regularly during the winter months, as dirt and road salt are difficult to remove and cause damage to the vehicle.
- Immediately remove items such as gasoline, diesel fuel, bird droppings and insect deposits because they can cause damage to the vehicle’s paintwork and trim over time. Use Motorcraft Bug and Tar Remover (ZC-42) which is available from your authorized dealer.
- Remove any exterior accessories, such as antennas, before entering a car wash.
- **Suntan lotions and insect repellents can damage any painted surface; if these substances come in contact with your vehicle, wash off as soon as possible.**

### Exterior chrome

- Wash the vehicle first, using cool or lukewarm water and a neutral pH shampoo, such as Motorcraft Detail Wash (ZC-3-A).
- Use Motorcraft Custom Bright Metal Cleaner (ZC-15), available from your authorized dealer. Apply the product as you would a wax to clean bumpers and other chrome parts; allow the cleaner to dry for a few minutes, then wipe off the haze with a clean, dry rag.
- **Never use abrasive materials such as steel wool or plastic pads as they can scratch the chrome surface.**
- After polishing chrome bumpers, apply a coating of Motorcraft Premium Liquid Wax (ZC-53-A), available from your authorized dealer, or an equivalent quality product to help protect from environmental effects.

## Cleaning

### WAXING

- Wash the vehicle first.
- Do not use waxes that contain abrasives; use Motorcraft Premium Liquid Wax (ZC-53-A), which is available from your authorized dealer, or an equivalent quality product.
- Do not allow paint sealant to come in contact with any non-body (low-gloss black) colored trim, such as grained door handles, roof racks, bumpers, side moldings, mirror housings or the windshield cowl area. The paint sealant will “gray” or stain the parts over time.

### PAINT CHIPS

Your authorized dealer has touch-up paint to match your vehicle's color. Take your color code (printed on a sticker in the driver's door jamb) to your authorized dealer to ensure you get the correct color.

- Remove particles such as bird droppings, tree sap, insect deposits, tar spots, road salt and industrial fallout before repairing paint chips.
- Always read the instructions before using the products.

### ALUMINUM WHEELS AND WHEEL COVERS

Aluminum wheels and wheel covers are coated with a clearcoat paint finish. In order to maintain their shine:

- Clean weekly with Motorcraft Wheel and Tire Cleaner (ZC-37-A), which is available from your authorized dealer. Heavy dirt and brake dust accumulation may require agitation with a sponge. Rinse thoroughly with a strong stream of water.
- Never apply any cleaning chemical to hot or warm wheel rims or covers.
- Some automatic car washes may cause damage to the finish on your wheel rims or covers. Chemical-strength cleaners, or cleaning chemicals, in combination with brush agitation to remove brake dust and dirt, could wear away the clearcoat finish over time.
- Do not use hydrofluoric acid-based or high caustic-based wheel cleaners, steel wool, fuels or strong household detergent.
- To remove tar and grease, use Motorcraft Bug and Tar Remover (ZC-42), available from your authorized dealer.

## Cleaning

### ENGINE

Engines are more efficient when they are clean because grease and dirt buildup keep the engine warmer than normal.

When washing:

- Take care when using a power washer to clean the engine. The high-pressure fluid could penetrate the sealed parts and cause damage.
- Do not spray a hot engine with cold water to avoid cracking the engine block or other engine components.
- Spray Motorcraft Engine Shampoo and Degreaser (ZC-20) on all parts that require cleaning and pressure rinse clean. In Canada use Motorcraft Engine Shampoo (CXC-66-A).
- Never wash or rinse the engine while it is running; water in the running engine may cause internal damage.
- Cover the highlighted areas to prevent water damage when cleaning the engine.

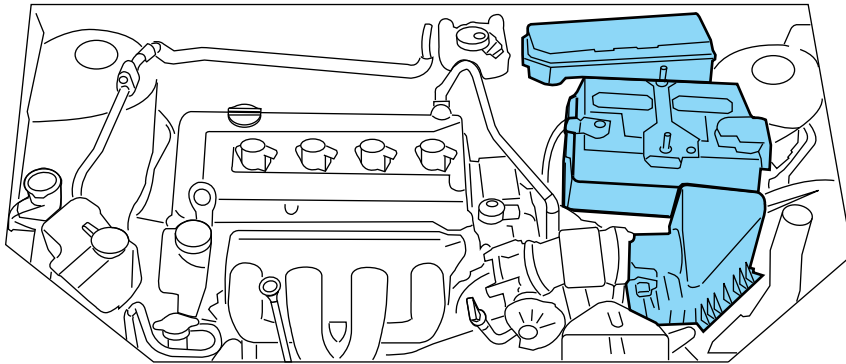

### PLASTIC (NON-PAINTED) EXTERIOR PARTS

Use only approved products to clean plastic parts. These products are available from your authorized dealer.

- For routine cleaning, use Motorcraft Detail Wash (ZC-3-A).
- If tar or grease spots are present, use Motorcraft Bug and Tar Remover (ZC-42).
- For plastic headlamp lenses, use Motorcraft Ultra Clear Spray Glass Cleaner (ZC-23).

## Cleaning

### WINDOWS AND WIPER BLADES

The windshield, rear and side windows and the wiper blades should be cleaned regularly. If the wipers do not wipe properly, substances on the vehicle's glass or the wiper blades may be the cause. These may include hot wax treatments used by commercial car washes, water repellent coatings, tree sap, or other organic contamination; these contaminants may cause squeaking or chatter noise from the blades, and streaking and smearing of the windshield. To clean these items, follow these tips:

- The windshield, rear windows and side windows may be cleaned with a non-abrasive cleaner such as Motorcraft Ultra-Clear Spray Glass Cleaner (ZC-23), available from your authorized dealer.
- The wiper blades can be cleaned with isopropyl (rubbing) alcohol or Motorcraft Premium Windshield Washer Concentrate (ZC-32-A), available from your authorized dealer. This washer fluid contains special solution in addition to alcohol which helps to remove the hot wax deposited on the wiper blade and windshield from automated car wash facilities. Be sure to replace wiper blades when they appear worn or do not function properly.
- Do not use abrasives, as they may cause scratches.
- Do not use fuel, kerosene, or paint thinner to clean any parts.

If you cannot remove those streaks after cleaning with the glass cleaner or if the wipers chatter and move in a jerky motion, clean the outer surface of the windshield and the wiper blades using a sponge or soft cloth with a neutral detergent or mild-abrasive cleaning solution. After cleaning, rinse the windshield and wiper blades with clean water. The windshield is clean if beads do not form when you rinse the windshield with water.

**Do not use sharp objects, such as a razor blade, to clean the inside of the rear window or to remove decals, as it may cause damage to the rear window defroster's heated grid lines.**

### INSTRUMENT PANEL/INTERIOR TRIM AND CLUSTER LENS

Clean the instrument panel, interior trim areas and cluster lens with a clean and damp white cotton cloth, then with a clean and dry white cotton cloth; you may also use Motorcraft Dash & Vinyl Cleaner (ZC-38-A) on the instrument panel and interior trim areas.

- Avoid cleaners or polishes that increase the gloss of the upper portion of the instrument panel. The dull finish in this area helps protect the driver from undesirable windshield reflection.



## Cleaning

- Be certain to wash or wipe your hands clean if you have been in contact with certain products such as insect repellent and suntan lotion in order to avoid possible damage to the interior painted surfaces.
- Do not use household or glass cleaners as these may damage the finish of the instrument panel, interior trim and cluster lens.



**WARNING:** Do not use chemical solvents or strong detergents when cleaning the steering wheel or instrument panel to avoid contamination of the airbag system.

If a staining liquid like coffee/juice has been spilled on the instrument panel or on interior trim surfaces, clean as follows:

1. Wipe up spilled liquid using a clean, white, cotton cloth.
2. Apply Motorcraft Deluxe Leather and Vinyl Cleaner (ZC-11-A) [In Canada use Motorcraft Multi-Purpose Cleaner (CXC-101)] to the wiped area and spread around evenly.
3. Apply more Motorcraft cleaner to a clean, white, cotton cloth and press the cloth onto the soiled area—allow this to set at room temperature for 30 minutes.
4. Remove the soaked cloth, and if it is not soiled badly, use this cloth to clean the area by using a rubbing motion for 60 seconds.
5. Following this, wipe area dry with a clean, white, cotton cloth.

### INTERIOR

For fabric, carpets, cloth seats, safety belts and seats equipped with side airbags:

- Remove dust and loose dirt with a vacuum cleaner.
- Remove light stains and soil with Motorcraft Professional Strength Carpet & Upholstery Cleaner (ZC-54).
- If grease or tar is present on the material, spot-clean the area first with Motorcraft Spot and Stain Remover (ZC-14). In Canada, use Motorcraft Multi-Purpose Cleaner (CXC-101).
- If a ring forms on the fabric after spot cleaning, clean the entire area immediately (but do not oversaturate) or the ring will set.
- Do not use household cleaning products or glass cleaners, which can stain and discolor the fabric and affect the flame retardant abilities of the seat materials.

## Cleaning



**WARNING:** Do not use cleaning solvents, bleach or dye on the vehicle's safety belts, as these actions may weaken the belt webbing.



**WARNING:** On vehicles equipped with seat-mounted airbags, do not use chemical solvents or strong detergents. Such products could contaminate the side-airbag system and affect performance of the side airbag in a collision.

### LEATHER SEATS (IF EQUIPPED)

Your leather seating surfaces have a clear, protective coating over the leather.

- For routine cleaning, wipe the surface with a soft, damp cloth. For more thorough cleaning, wipe the surface with a mild soap and water solution. In Canada, use Motorcraft Vinyl Cleaner (CXC-93). Dry the area with a soft cloth.
- If the leather cannot be completely cleaned using a mild soap and water solution, the leather may be cleaned using a commercially available cleaning product designed for automotive leather.
- Do not use household cleaning products, alcohol solutions, solvents or cleaners intended for rubber, vinyl and plastics, or oil/petroleum-based leather conditioners. These products may cause premature wearing of the clear, protective coating.

**Note:** In some instances, color or dye transfer can occur when wet clothing comes in contact with leather upholstery. If this occurs, the leather should be cleaned immediately to avoid permanent staining.

### UNDERBODY

Flush the complete underside of your vehicle frequently. Keep body and door drain holes free from packed dirt.

### FORD AND LINCOLN MERCURY CAR CARE PRODUCTS

Your Ford or Lincoln Mercury authorized dealer has many quality products available to clean your vehicle and protect its finishes. These quality products have been specifically engineered to fulfill your automotive needs; they are custom designed to complement the style and appearance of your vehicle. Each product is made from high quality materials that meet or exceed rigid specifications. For best results, use the following products or products of equivalent quality:

- Motorcraft Bug and Tar Remover (ZC-42)
- Motorcraft Car Wash (Canada only) (CXC-83)
- Motorcraft Custom Bright Metal Cleaner (ZC-15)
- Motorcraft Custom Clear Coat Polish (ZC-8-A)
- Motorcraft Custom Vinyl Protectant (ZC-40-A)
- Motorcraft Dash and Vinyl Cleaner (ZC-38-A)
- Motorcraft Deluxe Leather and Vinyl Cleaner (U.S. only) (ZC-11-A)
- Motorcraft Leather Care Kit (U.S. only) (ZC-11-D)
- Motorcraft Detail Wash (ZC-3-A)
- Motorcraft Dusting Cloth (ZC-24)
- Motorcraft Engine Shampoo and Degreaser (U.S. only) (ZC-20)
- Motorcraft Engine Shampoo (Canada only) (CXC-66-A)
- Motorcraft Multi-Purpose Cleaner (Canada only) (CXC-101)
- Motorcraft Premium Glass Cleaner (Canada only) (CXC-100)
- Motorcraft Premium Liquid Wax (ZC-53-A)
- Motorcraft Premium Windshield Washer Concentrate (U.S. only) (ZC-32-A)
- Motorcraft Professional Strength Carpet & Upholstery Cleaner (ZC-54)
- Motorcraft Spot and Stain Remover (U.S. only) (ZC-14)
- Motorcraft Tire Clean and Shine (ZC-28)
- Motorcraft Triple Clean (U.S. only) (ZC-13)
- Motorcraft Ultra-Clear Spray Glass Cleaner (ZC-23)
- Motorcraft Vinyl Cleaner (Canada only) (CXC-93)
- Motorcraft Wash and Wax (Canada only) (CXC-95)
- Motorcraft Wheel and Tire Cleaner (ZC-37-A)

## Maintenance and Specifications

### SERVICE RECOMMENDATIONS

To help you service your vehicle, we provide *scheduled maintenance information* which makes tracking routine service easy.

If your vehicle requires professional service, your authorized dealer can provide the necessary parts and service. Check your *Warranty Guide/Customer Information Guide* to find out which parts and services are covered.

Use only recommended fuels, lubricants, fluids and service parts conforming to specifications. Motorcraft parts are designed and built to provide the best performance in your vehicle.

### PRECAUTIONS WHEN SERVICING YOUR VEHICLE

Be especially careful when inspecting or servicing your vehicle.

- Do not work on a hot engine.
- When the engine is running, make sure that loose clothing, jewelry or long hair does not get caught in moving parts.
- Do not work on a vehicle with the engine running in an enclosed space, unless you are sure you have enough ventilation.
- Keep all open flames and other burning (cigarettes) material away from the battery and all fuel related parts.

If you disconnect the battery, the engine must “relearn” its idle condition before your vehicle will drive properly, as explained in *Battery* in this section.

### Working with the engine off

- Automatic transmission:
  1. Set the parking brake and shift to P (Park).
  2. Turn off the engine and remove the key.
  3. Block the wheels.
- Manual transmission:
  1. Set the parking brake, depress the clutch and place the gearshift in 1 (First).
  2. Turn off the engine and remove the key.
  3. Block the wheels.

## Maintenance and Specifications

### Working with the engine on

- Automatic transmission:
  1. Set the parking brake and shift to P (Park).
  2. Block the wheels.
- Manual transmission:
  1. Set the parking brake, depress the clutch pedal, place the gearshift in N (Neutral), and release the clutch pedal.
  2. Block the wheels.



**WARNING:** To reduce the risk of vehicle damage and/or personal burn injuries, do not start your engine with the air cleaner removed and do not remove it while the engine is running.

### OPENING THE HOOD

1. Inside the vehicle, pull the hood release handle located under the instrument panel.

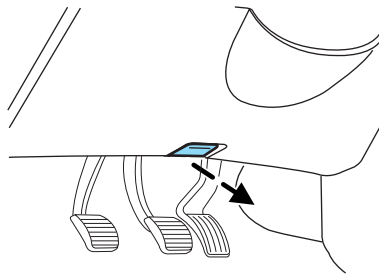

## Maintenance and Specifications

2. Go to the front of the vehicle and locate the auxiliary latch centered under the front of the hood and then release it by pushing the auxiliary latch to the left.

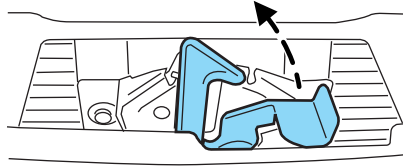

3. Lift the hood and locate the prop rod on the passenger side of the vehicle near the fender. Support the hood with the prop rod.

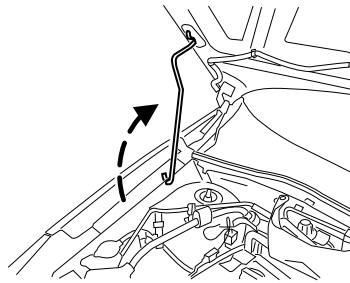

## Maintenance and Specifications

### IDENTIFYING COMPONENTS IN THE ENGINE COMPARTMENT

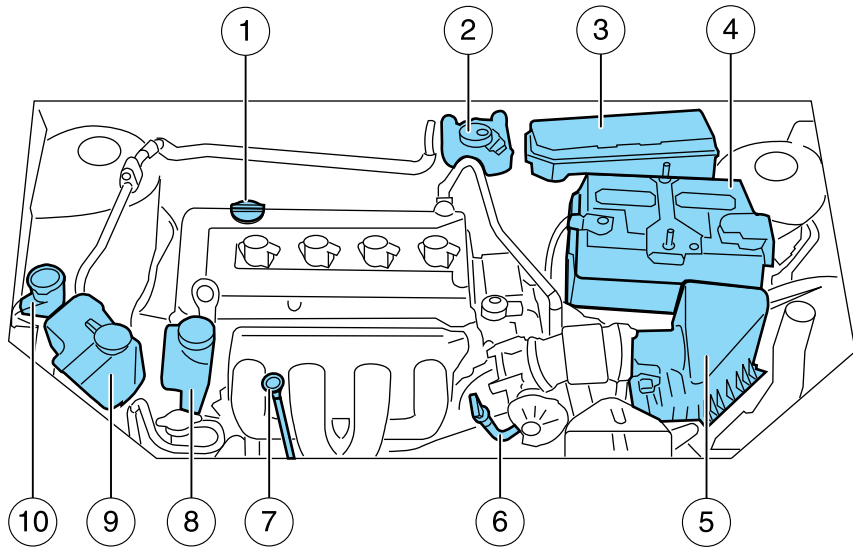

1. Engine oil filler cap
2. Brake/Clutch fluid reservoir
3. Power Distribution box
4. Battery
5. Air Filter
6. Automatic transmission fluid dipstick (if equipped)
7. Engine oil dipstick
8. Power steering fluid reservoir
9. Engine coolant reservoir
10. Windshield washer fluid reservoir

## Maintenance and Specifications

### WINDSHIELD WASHER FLUID

Add fluid to fill the reservoir if the level is low. In very cold weather, do not fill the reservoir completely.

Only use a washer fluid that meets Ford specification WSB-M8B16-A2. Do not use any special washer fluid such as windshield water repellent type fluid or bug wash. They may cause squeaking, chatter noise, streaking and smearing. Refer to the *Maintenance product specifications and capacities* section in this chapter.



State or local regulations on volatile organic compounds may restrict the use of methanol, a common windshield washer antifreeze additive. Washer fluids containing non-methanol antifreeze agents should be used only if they provide cold weather protection without damaging the vehicle's paint finish, wiper blades or washer system.

 **WARNING:** If you operate your vehicle in temperatures below 40°F (5°C), use washer fluid with antifreeze protection. Failure to use washer fluid with antifreeze protection in cold weather could result in impaired windshield vision and increase the risk of injury or accident.

**Note:** Do not put washer fluid in the engine coolant reservoir. Washer fluid placed in the cooling system may harm engine and cooling system components.

### CHANGING THE WIPER BLADES

1. Pull the wiper blade and arm away from the glass. Turn the blade at a right angle to the arm. Push the lock tab (A) to release the blade from the arm loop and pull the blade down toward the windshield to remove it from the arm.

2. Attach the new blade to the arm loop and pull it into place until a click is heard.

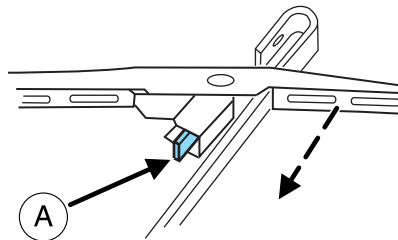

Replace wiper blades at least once per year for optimum performance.



## Maintenance and Specifications

Poor wiper quality can be improved by cleaning the wiper blades and the windshield. Refer to *Windows and wiper blades* in the *Cleaning* chapter.

To prolong the life of the wiper blades, it is highly recommended to scrape off the ice on the windshield before turning on the wipers. The layer of ice has many sharp edges and can damage the micro edge of the wiper rubber element.

### ENGINE OIL

#### Checking the engine oil

Refer to the *scheduled maintenance information* for the appropriate intervals for checking the engine oil.

1. Make sure the vehicle is on level ground.
2. Turn the engine off and wait 15 minutes for the oil to drain into the oil pan.
3. Set the parking brake and ensure the gearshift is securely latched in P (automatic transmission) or 1st (manual transmission).
4. Open the hood. Protect yourself from engine heat.
5. Locate and carefully remove the engine oil level dipstick.
6. Wipe the dipstick clean. Insert the dipstick fully, then remove it again.

- If the oil level is **between the MIN and MAX marks**, the oil level is acceptable. **DO NOT ADD OIL.**

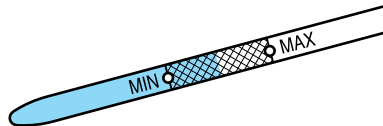

- If the oil level is below the MIN mark, add enough engine oil to raise the level within the MIN and MAX range. Refer to *Adding engine oil* in this chapter.

- **Oil levels above MAX mark may cause engine damage.** If the engine is overfilled, some oil must be removed from the engine by an authorized dealer.

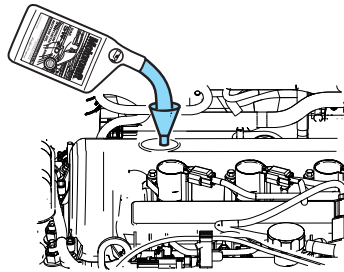

7. Put the dipstick back in and ensure it is fully seated.

#### Adding engine oil

1. Check the engine oil. For instructions, refer to *Checking the engine oil* in this chapter.

## Maintenance and Specifications

2. If the engine oil level is not within the normal range, add only certified engine oil of the recommended viscosity. Remove the engine oil filler cap and use a funnel to pour the engine oil into the opening.
3. Recheck the engine oil level. Make sure the oil level is not above the MAX mark on the engine oil level dipstick.
4. Install the dipstick and ensure it is fully seated.
5. Fully install the engine oil filler cap by turning the filler cap clockwise tightly until clicks are heard, or until it is snug.

**To avoid possible oil loss, DO NOT operate the vehicle with the engine oil level dipstick and/or the engine oil filler cap removed.**

### Engine oil and filter recommendations

Look for this certification trademark.

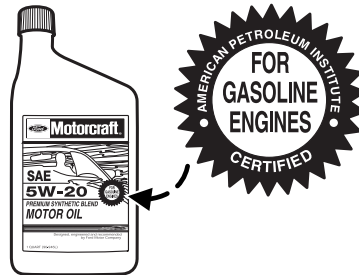

### Use SAE 5W-20 engine oil

Only use oils “Certified For Gasoline Engines” by the American Petroleum Institute (API). An oil with this trademark symbol conforms to the current engine and emission system protection standards and fuel economy requirements of the International Lubricant Standardization and Approval Committee (ILSAC), comprised of U.S. and Japanese automobile manufacturers.

To protect your engine and engine’s warranty, use Motorcraft SAE 5W-20 or an equivalent SAE 5W-20 oil meeting Ford specification WSS-M2C930-A. **SAE 5W-20 oil provides optimum fuel economy and durability performance meeting all requirements for your vehicle’s engine.** Refer to *Maintenance product specifications and capacities* later in this section for more information.

Do not use supplemental engine oil additives, cleaners or other engine treatments. They are unnecessary and could lead to engine damage that is not covered by Ford warranty.

## Maintenance and Specifications

Change your engine oil and filter according to the appropriate schedule listed in the *scheduled maintenance information*.

Ford production and Motorcraft replacement oil filters are designed for added engine protection and long life. If a replacement oil filter is used that does not meet Ford material and design specifications, start-up engine noises or knock may be experienced.

It is recommended you use the appropriate Motorcraft oil filter or another with equivalent performance for your engine application.

### BATTERY

Your vehicle is equipped with a Motorcraft maintenance-free battery which normally does not require additional water during its life of service.

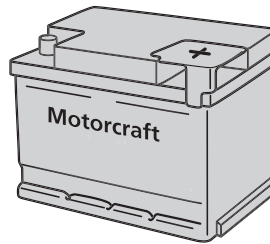

### **If your battery has a cover/shield, make sure it is reinstalled after the battery has been cleaned or replaced.**

For longer, trouble-free operation, keep the top of the battery clean and dry. Also, make certain the battery cables are always tightly fastened to the battery terminals.

If you see any corrosion on the battery or terminals, remove the cables from the terminals and clean with a wire brush. You can neutralize the acid with a solution of baking soda and water.

It is recommended that the negative battery cable terminal be disconnected from the battery if you plan to store your vehicle for an extended period of time. This will minimize the discharge of your battery during storage.

**Note: Electrical or electronic accessories or components added to the vehicle by the dealer or the owner may adversely affect battery performance and durability.**



**WARNING:** Batteries normally produce explosive gases which can cause personal injury. Therefore, do not allow flames, sparks or lighted substances to come near the battery. When working near the battery, always shield your face and protect your eyes. Always provide proper ventilation.

## Maintenance and Specifications

 **WARNING:** When lifting a plastic-cased battery, excessive pressure on the end walls could cause acid to flow through the vent caps, resulting in personal injury and/or damage to the vehicle or battery. Lift the battery with a battery carrier or with your hands on opposite corners.

 **WARNING:** Keep batteries out of reach of children. Batteries contain sulfuric acid. Avoid contact with skin, eyes or clothing. Shield your eyes when working near the battery to protect against possible splashing of acid solution. In case of acid contact with skin or eyes, flush immediately with water for a minimum of 15 minutes and get prompt medical attention. If acid is swallowed, call a physician immediately.

 **WARNING:** Battery posts, terminals and related accessories contain lead and lead compounds. **Wash hands after handling.**

Because your vehicle's engine is electronically controlled by a computer, some control conditions are maintained by power from the battery. When the battery is disconnected or a new battery is installed, the engine must relearn its idle and fuel trim strategy for optimum driveability and performance. To begin this process:

1. With the vehicle at a complete stop, set the parking brake.
  2. Put the gearshift in P (Park) (automatic transmission) or the neutral position (manual transmission), turn off all accessories and start the engine.
  3. Run the engine until it reaches normal operating temperature.
  4. Allow the engine to idle for at least one minute.
  5. Turn the A/C on and allow the engine to idle for at least one minute.
  6. Drive the vehicle to complete the relearning process.
- The vehicle may need to be driven 10 miles (16 km) or more to relearn the idle and fuel trim strategy.
  - **If you do not allow the engine to relearn its idle trim, the idle quality of your vehicle may be adversely affected until the idle trim is eventually relearned.**

When the battery is disconnected or a new battery installed, the transmission must learn its adaptive strategy. As a result of this, the

## Maintenance and Specifications

transmission may shift firmly. This operation is considered normal and will fully update transmission operation to its optimum shift feel.

If the battery has been disconnected or a new battery has been installed, the clock and the preset radio stations must be reset once the battery is reconnected.

- Always dispose of automotive batteries in a responsible manner. Follow your local authorized standards for disposal. Call your local authorized recycling center to find out more about recycling automotive batteries.

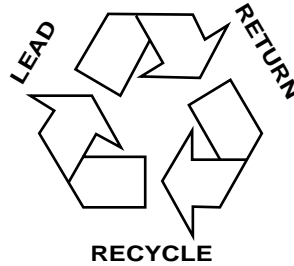

### ENGINE COOLANT

#### Checking engine coolant

The concentration and level of engine coolant should be checked at the intervals listed in *scheduled maintenance information*. The coolant concentration should be maintained at 50/50 coolant and distilled water, which equates to a freeze point of  $-34^{\circ}\text{F}$  ( $-36^{\circ}\text{C}$ ). Coolant concentration testing is possible with a hydrometer or antifreeze tester (such as the Rotunda Battery and Antifreeze Tester). The level of coolant should be maintained at the "FULL COLD" level or within the "COLD FILL RANGE" in the coolant reservoir. If the level falls below, add coolant per the instructions in the *Adding engine coolant* section.

Your vehicle was factory-filled with a 50/50 engine coolant and water concentration. If the concentration of coolant falls below 40% or above 60%, the engine parts could become damaged or not work properly. **A 50/50 mixture of coolant and water provides the following:**

- **Freeze protection down to  $-34^{\circ}\text{F}$  ( $-36^{\circ}\text{C}$ ).**
- **Boiling protection up to  $265^{\circ}\text{F}$  ( $129^{\circ}\text{C}$ ).**
- **Protection against rust and other forms of corrosion.**
- **Proper function of calibrated gauges.**

## Maintenance and Specifications

When the engine is cold, check the level of the engine coolant in the reservoir.

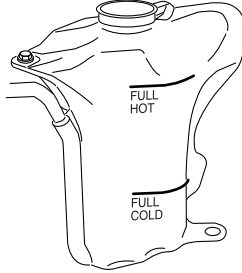

- The engine coolant should be at the “FULL COLD” level or within the “COLD FILL RANGE” as listed on the engine coolant reservoir (depending upon application).
- Refer to *scheduled maintenance information* for service interval schedules.
- Be sure to read and understand *Precautions when servicing your vehicle* in this chapter.

If the engine coolant has not been checked at the recommended interval, the engine coolant reservoir may become low or empty. If the reservoir is low or empty, add engine coolant to the reservoir. Refer to *Adding engine coolant* in this chapter.

**Note:** Automotive fluids are not interchangeable; do not use engine coolant, antifreeze or windshield washer fluid outside of its specified function and vehicle location.

### Adding engine coolant

When adding coolant, make sure it is a 50/50 mixture of engine coolant and distilled water. **When the engine is cool**, add the mixture to the coolant reservoir until the appropriate fill level is obtained.



**WARNING:** Do not add engine coolant when the engine is hot. Steam and scalding liquids released from a hot cooling system can burn you badly. Also, you can be burned if you spill coolant on hot engine parts.



**WARNING:** Do not put engine coolant in the windshield washer fluid container. If sprayed on the windshield, engine coolant could make it difficult to see through the windshield.

## Maintenance and Specifications

- **Add Motorcraft Premium Gold Engine Coolant or equivalent meeting Ford specification WSS-M97B51-A1.** Refer to *Maintenance product specifications and capacities* in this chapter.

**Note:** Use of Motorcraft Cooling System Stop Leak Pellets or an equivalent product meeting Ford specification WSS-M99B37-B6, may darken the color of Motorcraft Premium Gold Engine Coolant from yellow to golden tan.

- **Do not add/mix an orange-colored, extended life coolant such as Motorcraft Specialty Orange Engine Coolant, meeting Ford specification WSS-M97B44-D, or DEX-COOL® brand with the factory-filled coolant.** Mixing Motorcraft Specialty Orange Engine Coolant or any orange-colored extended life product such as DEX-COOL® brand with your factory filled coolant can result in degraded corrosion protection.
- A large amount of water without engine coolant may be added, in case of emergency, to reach a vehicle service location. In this instance, the cooling system must be drained and refilled with a 50/50 mixture of engine coolant and distilled water as soon as possible. Water alone (without engine coolant) can cause engine damage from corrosion, overheating or freezing.
- **Do not use alcohol, methanol, brine or any engine coolants mixed with alcohol or methanol antifreeze (coolant).** Alcohol and other liquids can cause engine damage from overheating or freezing.
- **Do not add extra inhibitors or additives to the coolant.** These can be harmful and compromise the corrosion protection of the engine coolant.

For vehicles with overflow coolant systems with a non-pressurized cap on the coolant recovery system, add coolant to the coolant recovery reservoir when the engine is cool. Add the proper mixture of coolant and water to the "FULL COLD" level. For all other vehicles which have a coolant degas system with a pressurized cap, or if it is necessary to remove the coolant pressure relief cap on the radiator of a vehicle with an overflow system, follow these steps to add engine coolant.



**WARNING:** To reduce the risk of personal injury, make sure the engine is cool before unscrewing the coolant pressure relief cap. The cooling system is under pressure; steam and hot liquid can come out forcefully when the cap is loosened slightly.

## Maintenance and Specifications

Add the proper mixture of coolant and water to the cooling system by following these steps:

1. Before you begin, turn the engine off and let it cool.
2. When the engine is cool, wrap a thick cloth around the coolant pressure relief cap on the coolant reservoir (a translucent plastic bottle). Slowly turn cap counterclockwise (left) until pressure begins to release.
3. Step back while the pressure releases.
4. When you are sure that all the pressure has been released, use the cloth to turn it counterclockwise and remove the cap.
5. Fill the coolant reservoir slowly with the proper coolant mixture, to within the “COLD FILL RANGE” or the “FULL COLD” level on the reservoir. If you removed the radiator cap in an overflow system, fill the radiator until the coolant is visible and radiator is almost full.
6. Replace the cap. Turn until tightly installed. Cap must be tightly installed to prevent coolant loss.

After any coolant has been added, check the coolant concentration (refer to *Checking engine coolant*). If the concentration is not 50/50 (protection to  $-34^{\circ}\text{F}/-36^{\circ}\text{C}$ ), drain some coolant and adjust the concentration. It may take several drains and additions to obtain a 50/50 coolant concentration.

Whenever coolant has been added, the coolant level in the coolant reservoir should be checked the next few times you drive the vehicle. If necessary, add enough 50/50 concentration of engine coolant and distilled water to bring the liquid level to the proper level.

If you have to add more than 1.0 quart (1.0 liter) of engine coolant per month, have your authorized dealer check the engine cooling system. Your cooling system may have a leak. Operating an engine with a low level of coolant can result in engine overheating and possible engine damage.

### Recycled engine coolant

Ford Motor Company does NOT recommend the use of recycled engine coolant in vehicles originally equipped with Motorcraft Premium Gold Engine Coolant since a Ford-approved recycling process is not yet available.



Used engine coolant should be disposed of in an appropriate manner. Follow your community's regulations and standards for recycling and disposing of automotive fluids.



## Maintenance and Specifications

### Coolant refill capacity

To find out how much fluid your vehicle's cooling system can hold, refer to *Maintenance product specifications and capacities* in this chapter. Fill your engine coolant reservoir as outlined in *Adding engine coolant* in this section.

### Severe climates

If you drive in extremely cold climates (less than  $-34^{\circ}\text{F}$  [ $-36^{\circ}\text{C}$ ]):

- **It may be necessary to increase the coolant concentration above 50%.**
- **NEVER increase the coolant concentration above 60%.**
- **Increased engine coolant concentrations above 60% will decrease the overheat protection characteristics of the engine coolant and may cause engine damage.**
- **Refer to the chart on the coolant container to ensure the coolant concentration in your vehicle will provide adequate freeze protection at the temperatures in which you drive in the winter months.**

If you drive in extremely hot climates:

- **It is still necessary to maintain the coolant concentration above 40%.**
- **NEVER decrease the coolant concentration below 40%.**
- **Decreased engine coolant concentrations below 40% will decrease the corrosion protection characteristics of the engine coolant and may cause engine damage.**
- **Decreased engine coolant concentrations below 40% will decrease the freeze protection characteristics of the engine coolant and may cause engine damage.**
- **Refer to the chart on the coolant container to ensure the coolant concentration in your vehicle will provide adequate protection at the temperatures in which you drive.**

Vehicles driven year-round in non-extreme climates should use a 50/50 mixture of engine coolant and distilled water for optimum cooling system and engine protection.

### What you should know about fail-safe cooling

If the engine coolant supply is depleted, this feature allows the vehicle to be driven temporarily before incremental component damage is incurred. The "fail-safe" distance depends on ambient temperatures, vehicle load and terrain.

## Maintenance and Specifications

### **How fail-safe cooling works**

If the engine begins to overheat:

- The engine coolant temperature gauge will move to the red (hot) area.
- The  (engine coolant temperature) indicator light will illuminate.

If the engine reaches a preset over-temperature condition, the engine will automatically switch to alternating cylinder operation. Each disabled cylinder acts as an air pump and cools the engine.

When this occurs the vehicle will still operate. However:

- The engine power will be limited.
- The air conditioning system will be disabled.

Continued operation will increase the engine temperature:

- The engine will completely shut down.
- Steering and braking effort will increase.

Once the engine temperature cools, the engine can be re-started. Take your vehicle to an authorized dealer as soon as possible to minimize engine damage.

### **When fail-safe mode is activated**

You have limited engine power when in the fail-safe mode, so drive the vehicle with caution. The vehicle will not be able to maintain high speed operation and the engine will run rough. Remember that the engine is capable of completely shutting down automatically to prevent engine damage, therefore:

1. Pull off the road as soon as safely possible and turn off the engine.
2. Arrange for the vehicle to be taken to an authorized dealer.
3. If this is not possible, wait a short period for the engine to cool.
4. Check the coolant level and replenish if low.



**WARNING:** Never remove the coolant reservoir cap while the engine is running or hot.

5. Restart the engine and take your vehicle to an authorized dealer.

**Driving the vehicle without repairing the engine problem increases the chance of engine damage. Take your vehicle to an authorized dealer as soon as possible.**

## Maintenance and Specifications

### FUEL FILTER

Your vehicle is equipped with a lifetime fuel filter that is integrated with the fuel tank. Regular maintenance or replacement is not needed.

### WHAT YOU SHOULD KNOW ABOUT AUTOMOTIVE FUELS

#### Important safety precautions



**WARNING:** Do not overfill the fuel tank. The pressure in an overfilled tank may cause leakage and lead to fuel spray and fire.



**WARNING:** The fuel system may be under pressure. If the fuel filler cap is venting vapor or if you hear a hissing sound, wait until it stops before completely removing the fuel filler cap. Otherwise, fuel may spray out and injure you or others.



**WARNING:** If you do not use the proper fuel filler cap, excessive vacuum in the fuel tank may damage the fuel system or cause the fuel cap to disengage in a collision, which may result in serious personal injury.



**WARNING:** Automotive fuels can cause serious injury or death if misused or mishandled.



**WARNING:** Gasoline may contain benzene, which is a cancer-causing agent.

Observe the following guidelines when handling automotive fuel:

- Extinguish all smoking materials and any open flames before refueling your vehicle.
- Always turn off the vehicle before refueling.
- Automotive fuels can be harmful or fatal if swallowed. Fuel such as gasoline is highly toxic and if swallowed can cause death or permanent injury. If fuel is swallowed, call a physician immediately, even if no symptoms are immediately apparent. The toxic effects of fuel may not be visible for hours.



## Maintenance and Specifications

- Avoid inhaling fuel vapors. Inhaling too much fuel vapor of any kind can lead to eye and respiratory tract irritation. In severe cases, excessive or prolonged breathing of fuel vapor can cause serious illness and permanent injury.
- Avoid getting fuel liquid in your eyes. If fuel is splashed in the eyes, remove contact lenses (if worn), flush with water for 15 minutes and seek medical attention. Failure to seek proper medical attention could lead to permanent injury.
- Fuels can also be harmful if absorbed through the skin. If fuel is splashed on the skin and/or clothing, promptly remove contaminated clothing and wash skin thoroughly with soap and water. Repeated or prolonged skin contact with fuel liquid or vapor causes skin irritation.
- Be particularly careful if you are taking “Antabuse” or other forms of disulfiram for the treatment of alcoholism. Breathing gasoline vapors, or skin contact could cause an adverse reaction. In sensitive individuals, serious personal injury or sickness may result. If fuel is splashed on the skin, promptly wash skin thoroughly with soap and water. Consult a physician immediately if you experience an adverse reaction.



**WARNING:** When refueling always shut the engine off and never allow sparks or open flames near the filler neck. Never smoke while refueling. Fuel vapor is extremely hazardous under certain conditions. Care should be taken to avoid inhaling excess fumes.



**WARNING:** The flow of fuel through a fuel pump nozzle can produce static electricity, which can cause a fire if fuel is pumped into an ungrounded fuel container.

## Maintenance and Specifications

### Refueling



**WARNING:** Fuel vapor burns violently and a fuel fire can cause severe injuries. To help avoid injuries to you and others:

- Read and follow all the instructions on the pump island;
- Turn off your engine when you are refueling;
- Do not smoke if you are near fuel or refueling your vehicle;
- Keep sparks, flames and smoking materials away from fuel;
- Stay outside your vehicle and do not leave the fuel pump unattended when refueling your vehicle — this is against the law in some places;
- Keep children away from the fuel pump; never let children pump fuel.

Use the following guidelines to avoid electrostatic charge build-up when filling an ungrounded fuel container:

- Place approved fuel container on the ground.
- DO NOT fill a fuel container while it is in the vehicle (including the cargo area).
- Keep the fuel pump nozzle in contact with the fuel container while filling.
- DO NOT use a device that would hold the fuel pump handle in the fill position.

### Fuel filler cap



When fueling your vehicle:



1. Turn the engine off.
2. Carefully turn the filler cap counterclockwise until it spins off.
3. Pull to remove the cap from the fuel filler pipe.
4. To install the cap, align the tabs on the cap with the notches on the filler pipe.
5. Turn the filler cap clockwise 1/4 of a turn until at least one click is heard.

If the check fuel cap light  or a “check fuel cap” message comes on, the fuel filler cap may not be properly installed. The light or message can come on after several driving events after you’ve refueled your vehicle.

At the next opportunity, safely pull off of the road, remove the fuel filler cap, align the cap properly and reinstall it. The check fuel cap

## Maintenance and Specifications

light  or “check fuel cap” message may not reset immediately; it may take several driving cycles for the check fuel cap light  or “check fuel cap” message to turn off. A driving cycle consists of an engine start-up (after four or more hours with the engine off) followed by city and highway driving.

Continuing to drive with the check fuel cap light  or “check fuel cap” message on may cause the  light to turn on as well.

**If you must replace the fuel filler cap, replace it with a fuel filler cap that is designed for your vehicle. The customer warranty may be void for any damage to the fuel tank or fuel system if the correct genuine Ford, Motorcraft or other certified fuel filler cap is not used.**

 **WARNING:** The fuel system may be under pressure. If the fuel filler cap is venting vapor or if you hear a hissing sound, wait until it stops before completely removing the fuel filler cap. Otherwise, fuel may spray out and injure you or others.

 **WARNING:** If you do not use the proper fuel filler cap, excessive vacuum in the fuel tank may damage the fuel system or cause the fuel cap to disengage in a collision, which may result in personal injury.

FORD RECOMMENDS BP



### Choosing the right fuel

Use only UNLEADED fuel or UNLEADED fuel blended with a maximum of 10% ethanol. Do not use fuel ethanol (E85), diesel, methanol, leaded fuel or any other fuel. The use of leaded fuel is prohibited by law and could damage your vehicle.

Your vehicle was not designed to use fuel or fuel additives with metallic compounds, including manganese-based additives.

## Maintenance and Specifications

**Note:** Use of any fuel other than those recommended may cause powertrain damage, a loss of vehicle performance, and repairs may not be covered under warranty.

### Octane recommendations

Your vehicle is designed to use “Regular” unleaded gasoline with a pump (R+M)/2 octane rating of 87.

We do not recommend the use of gasolines labeled as “Regular” in high altitude areas that are sold with octane ratings less than 87.

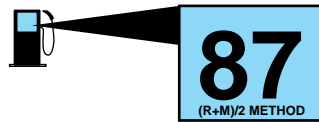

Do not be concerned if your engine sometimes knocks lightly. However, if it knocks heavily under most driving conditions while you are using fuel with the recommended octane rating, see your authorized dealer to prevent any engine damage.

### Fuel quality

If you are experiencing starting, rough idle or hesitation driveability problems, try a different brand of unleaded gasoline. “Premium” unleaded gasoline is not recommended for vehicles designed to use “Regular” unleaded gasoline because it may cause these problems to become more pronounced. If the problems persist, see your authorized dealer.

Do not add aftermarket fuel additive products to your fuel tank. It should not be necessary to add any aftermarket products to your fuel tank if you continue to use high quality fuel of the recommended octane rating. These products have not been approved for your engine and could cause damage to the fuel system. Repairs to correct the effects of using an aftermarket product in your fuel may not be covered by your warranty.

Many of the world’s automakers approved the World-Wide Fuel Charter that recommends gasoline specifications to provide improved performance and emission control system protection for your vehicle. Gasolines that meet the World-Wide Fuel Charter should be used when available. Ask your fuel supplier about gasolines that meet the World-Wide Fuel Charter.

### Cleaner air



Ford endorses the use of reformulated “cleaner-burning” gasolines to improve air quality, per the recommendations in the *Choosing the right fuel* section.

## Maintenance and Specifications

### Running out of fuel

Avoid running out of fuel because this situation may have an adverse effect on powertrain components.

If you have run out of fuel:

- You may need to cycle the ignition from off to on several times after refueling to allow the fuel system to pump the fuel from the tank to the engine. On restarting, cranking time will take a few seconds longer than normal.
- Normally, adding 1 gallon (3.8L) of fuel is enough to restart the engine. If the vehicle is out of fuel and on a steep grade, more than 1 gallon (3.8L) may be required.
- The *Service engine soon*  indicator may come on. For more information on the *Service engine soon*  indicator, refer to *Warning lights and chimes* in the *Instrument Cluster* chapter.

### ESSENTIALS OF GOOD FUEL ECONOMY

#### Measuring techniques

Your best source of information about actual fuel economy is you, the driver. You must gather information as accurately and consistently as possible. Fuel expense, frequency of fill-ups or fuel gauge readings are NOT accurate as a measure of fuel economy. We do not recommend taking fuel economy measurements during the first 1,000 miles (1,600 km) of driving (engine break-in period). You will get a more accurate measurement after 2,000 miles–3,000 miles (3,000 km–5,000 km).

#### Filling the tank

The advertised fuel capacity of the fuel tank on your vehicle is equal to the rated refill capacity of the fuel tank as listed in the *Maintenance product specifications and capacities* section of this chapter.

The advertised capacity is the amount of the indicated capacity and the empty reserve combined. Indicated capacity is the difference in the amount of fuel in a full tank and a tank when the fuel gauge indicates empty. Empty reserve is the small amount of fuel remaining in the fuel tank after the fuel gauge indicates empty.

**The amount of usable fuel in the empty reserve varies and should not be relied upon to increase driving range. When refueling your vehicle after the fuel gauge indicates empty, you might not be**



## Maintenance and Specifications

**able to refuel the full amount of the advertised capacity of the fuel tank due to the empty reserve still present in the tank.**

For consistent results when filling the fuel tank:

- Turn the engine/ignition switch to the off position prior to refueling, an error in the reading will result if the engine is left running.
- Use the same filling rate setting (low — medium — high) each time the tank is filled.
- Allow no more than two automatic click-offs when filling.
- Always use fuel with the recommended octane rating.
- Use a known quality gasoline, preferably a national brand.
- Use the same side of the same pump and have the vehicle facing the same direction each time you fill up.
- Have the vehicle loading and distribution the same every time.

Your results will be most accurate if your filling method is consistent.

### Calculating fuel economy

1. Fill the fuel tank completely and record the initial odometer reading (in miles or kilometers).
2. Each time you fill the tank, record the amount of fuel added (in gallons or liters).
3. After at least three to five tank fill-ups, fill the fuel tank and record the current odometer reading.
4. Subtract your initial odometer reading from the current odometer reading.
5. Follow one of the simple calculations in order to determine fuel economy:

Calculation 1: **Divide total miles traveled by total gallons used.**

Calculation 2: **Multiply liters used by 100, then divide by total kilometers traveled.**

Keep a record for at least one month and record the type of driving (city or highway). This will provide an accurate estimate of the vehicle's fuel economy under current driving conditions. Additionally, keeping records during summer and winter will show how temperature impacts fuel economy. In general, lower temperatures give lower fuel economy.

### Driving style — good driving and fuel economy habits

Give consideration to the lists that follow and you may be able to change a number of variables and improve your fuel economy.

## Maintenance and Specifications

### **Habits**

- Smooth, moderate operation can yield up to 10% savings in fuel.
- Steady speeds without stopping will usually give the best fuel economy.
- Idling for long periods of time (greater than one minute) may waste fuel.
- Anticipate stopping; slowing down may eliminate the need to stop.
- Sudden or hard accelerations may reduce fuel economy.
- Slow down gradually.
- Driving at reasonable speeds (traveling at 55 mph [88 km/h] uses 15% less fuel than traveling at 65 mph [105 km/h]).
- Revving the engine before turning it off may reduce fuel economy.
- Using the air conditioner or defroster may reduce fuel economy.
- You may want to turn off the speed control in hilly terrain if unnecessary shifting between the top gears occurs. Unnecessary shifting of this type could result in reduced fuel economy.
- Warming up a vehicle on cold mornings is not required and may reduce fuel economy.
- Resting your foot on the brake pedal while driving may reduce fuel economy.
- Combine errands and minimize stop-and-go driving.

### **Maintenance**

- Keep tires properly inflated and use only recommended size.
- Operating a vehicle with the wheels out of alignment will reduce fuel economy.
- Use recommended engine oil. Refer to *Maintenance product specifications and capacities* in this chapter.
- Perform all regularly scheduled maintenance items. Follow the recommended maintenance schedule and owner maintenance checks found in *scheduled maintenance information*.

### **Conditions**

- Heavily loading a vehicle or towing a trailer may reduce fuel economy at any speed.
- Carrying unnecessary weight may reduce fuel economy (approximately 1 mpg [0.4 km/L] is lost for every 400 lb [180 kg] of weight carried).

## Maintenance and Specifications

- Adding certain accessories to your vehicle (for example bug deflectors, rollbars/light bars, running boards, ski/luggage racks) may reduce fuel economy.
- Using fuel blended with alcohol may lower fuel economy.
- Fuel economy may decrease with lower temperatures during the first 8–10 miles (12–16 km) of driving.
- Driving on flat terrain offers improved fuel economy as compared to driving on hilly terrain.
- Transmissions give their best fuel economy when operated in the top cruise gear and with steady pressure on the gas pedal.
- Close windows for high speed driving.

### EPA fuel economy estimates

Every new vehicle should have a window sticker containing EPA fuel economy estimates. Contact your authorized dealer if the window sticker is not supplied with your vehicle. The EPA fuel economy estimates should be your guide for the fuel economy comparisons with other vehicles. Your fuel economy may vary depending upon the method of operation and conditions.

### EMISSION CONTROL SYSTEM

Your vehicle is equipped with various emission control components and a catalytic converter which will enable your vehicle to comply with applicable exhaust emission standards. To make sure that the catalytic converter and other emission control components continue to work properly:

- Use only the specified fuel listed.
- Avoid running out of fuel.
- Do not turn off the ignition while your vehicle is moving, especially at high speeds.
- Have the items listed in *scheduled maintenance information* performed according to the specified schedule.

The scheduled maintenance items listed in *scheduled maintenance information* are essential to the life and performance of your vehicle and to its emissions system.

If other than Ford, Motorcraft or Ford-authorized parts are used for maintenance replacements or for service of components affecting emission control, such non-Ford parts should be equivalent to genuine Ford Motor Company parts in performance and durability.

## Maintenance and Specifications



**WARNING:** Do not park, idle, or drive your vehicle in dry grass or other dry ground cover. The emission system heats up the engine compartment and exhaust system, which can start a fire.

Illumination of the *Service engine soon*  indicator, charging system warning light or the temperature warning light, fluid leaks, strange odors, smoke or loss of engine power could indicate that the emission control system is not working properly.

An improperly operating or damaged exhaust system may allow exhaust to enter the vehicle. Have a damaged or improperly operating exhaust system inspected and repaired immediately.





**WARNING:** Exhaust leaks may result in entry of harmful and potentially lethal fumes into the passenger compartment.

Do not make any unauthorized changes to your vehicle or engine. By law, vehicle owners and anyone who manufactures, repairs, services, sells, leases, trades vehicles, or supervises a fleet of vehicles are not permitted to intentionally remove an emission control device or prevent it from working. Information about your vehicle's emission system is on the Vehicle Emission Control Information Decal located on or near the engine. This decal also lists engine displacement.

Please consult your *Warranty Guide/Customer Information Guide* for complete emission warranty information.

### On board diagnostics (OBD-II)



Your vehicle is equipped with a computer that monitors the engine's emission control system. This system is commonly known as the On Board Diagnostics System (OBD-II). The OBD-II system protects the environment by ensuring that your vehicle continues to meet government emission standards. The OBD-II system also assists your authorized dealer in properly servicing your vehicle. When the *Service engine soon*  indicator illuminates, the OBD-II system has detected a malfunction. Temporary malfunctions may cause the *Service engine soon*  indicator to illuminate. Examples are:

1. The vehicle has run out of fuel—the engine may misfire or run poorly.
2. Poor fuel quality or water in the fuel—the engine may misfire or run poorly.
3. The fuel cap may not have been securely tightened. See *Fuel filler cap* in this chapter.

## Maintenance and Specifications

4. Driving through deep water—the electrical system may be wet.



These temporary malfunctions can be corrected by filling the fuel tank with good quality fuel, properly tightening the fuel cap or letting the electrical system dry out. After three driving cycles without these or any other temporary malfunctions present, the *Service engine soon*  indicator should stay off the next time the engine is started. A driving cycle consists of a cold engine startup followed by mixed city/highway driving. No additional vehicle service is required.

If the *Service engine soon*  indicator remains on, have your vehicle serviced at the first available opportunity. Although some malfunctions detected by the OBD-II may not have symptoms that are apparent, continued driving with the *Service engine soon*  indicator on can result in increased emissions, lower fuel economy, reduced engine and transmission smoothness, and lead to more costly repairs.

### Readiness for Inspection/Maintenance (I/M) testing

Some state/provincial and local governments may have Inspection/Maintenance (I/M) programs to inspect the emission control equipment on your vehicle. Failure to pass this inspection could prevent you from getting a vehicle registration. Your vehicle may not pass the I/M test if the *Service engine soon*  indicator is on or not working properly (bulb is burned out), or if the OBD-II system has determined that some of the emission control systems have not been properly checked. In this case, the vehicle is considered not ready for I/M testing.

If the *Service engine soon*  indicator is on or the bulb does not work, the vehicle may need to be serviced. Refer to the On board diagnostics (OBD-II) description in this chapter.

If the vehicle's engine or transmission has just been serviced, or the battery has recently run down or been replaced, the OBD-II system may indicate that the vehicle is not ready for I/M testing. To determine if the vehicle is ready for I/M testing, turn the ignition key to the on position for 15 seconds without cranking the engine. If the *Service engine soon*  indicator blinks eight times, it means that the vehicle is not ready for I/M testing; if the *Service engine soon*  indicator stays on solid, it means that the vehicle is ready for I/M testing.

## Maintenance and Specifications

The OBD-II system is designed to check the emission control system during normal driving. A complete check may take several days. If the vehicle is not ready for I/M testing, the following driving cycle consisting of mixed city and highway driving may be performed:

15 minutes of steady driving on an expressway/highway followed by 20 minutes of stop-and-go driving with at least four 30-second idle periods.

Allow the vehicle to sit for at least eight hours without starting the engine. Then, start the engine and complete the above driving cycle. The engine must warm up to its normal operating temperature. Once started, do not turn off the engine until the above driving cycle is complete. If the vehicle is still not ready for I/M testing, the above driving cycle will have to be repeated.

### POWER STEERING FLUID

Check the fluid. Refer to the *scheduled maintenance information* for service maintenance schedules.

1. Start the engine and let it run until it reaches normal operating temperature.
2. Turn the steering wheel left and right several times.
3. Turn the engine off.
4. Check the fluid level.
5. If the fluid is below the MIN line, add fluid in small amounts until it reaches the correct level (between the MIN and MAX lines). Refer to *Maintenance product specifications and capacities* in this chapter for the proper fluid type.

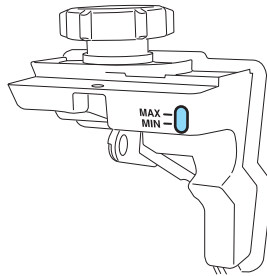

## Maintenance and Specifications

### BRAKE/CLUTCH FLUID

Brake and clutch systems are supplied from the same reservoir.

The fluid level will drop slowly as the brakes wear, and will rise when the brake components are replaced. Fluid levels between the “MIN” and “MAX” lines are within the normal operating range; there is no need to add fluid. If the fluid levels are outside of the normal operating range the performance of the system could be compromised; seek service from your authorized dealer immediately.

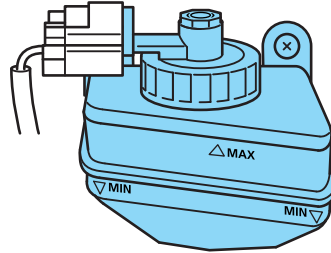

### TRANSMISSION FLUID

#### Checking automatic transmission fluid

Refer to your *scheduled maintenance information* for scheduled intervals for fluid checks and changes. Your transmission does not consume fluid. However, the fluid level should be checked if the transmission is not working properly, i.e., if the transmission slips or shifts slowly or if you notice some sign of fluid leakage.

**Automatic transmission fluid expands when warmed. To obtain an accurate fluid check, drive the vehicle until it is warmed up (approximately 20 miles [30 km]). If your vehicle has been operated for an extended period at high speeds, in city traffic during hot weather or pulling a trailer, the vehicle should be turned off for about 30 minutes to allow fluid to cool before checking.**

1. Drive the vehicle 20 miles (30 km) or until it reaches normal operating temperature.
2. Park the vehicle on a level surface and engage the parking brake.
3. With the parking brake engaged and your foot on the brake pedal, start the engine and move the gearshift lever through all of the gear ranges. Allow sufficient time for each gear to engage.
4. Latch the gearshift lever in P (Park) and leave the engine running.
5. Remove the dipstick, wiping it clean with a clean, dry lint free rag. If necessary, refer to *Identifying components in the engine compartment* in this chapter for the location of the dipstick.

## Maintenance and Specifications

6. Install the dipstick making sure it is fully seated in the filler tube.
7. Remove the dipstick and inspect the fluid level. The fluid should be in the designated areas for normal operating temperature.

### Low fluid level

Do not drive the vehicle if the fluid level is at the bottom of the dipstick and the outside temperatures are above 50°F (10°C).

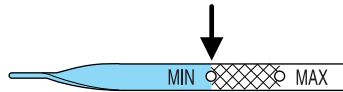

### Correct fluid level

The transmission fluid should be checked at normal operating temperatures 120°F-140°F (50°C-60°C) on a level surface. The normal operating temperature can be reached after approximately 20 miles (30 km) of driving.

The transmission fluid should be in this range if at normal operating temperature (120°F-140°F [50°C-60°C]).

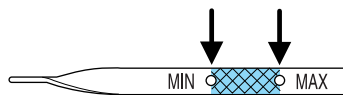

### High fluid level

Fluid levels above the safe range may result in transmission failure. An overfill condition of transmission fluid may cause shift and/or engagement concerns and/or possible damage.



High fluid levels can be caused by an overheating condition.

### Adjusting automatic transmission fluid levels

Before adding any fluid, make sure the correct type is used. The type of fluid used is normally indicated on the dipstick and also in the **Maintenance product specifications and capacities** section in this chapter.

**Use of a non-approved automatic transmission fluid may cause internal transmission component damage.**

If necessary, add fluid in 1/2 pint (250 mL) increments through the filler tube until the level is correct.



## Maintenance and Specifications

If an overfill occurs, excess fluid should be removed by an authorized dealer.

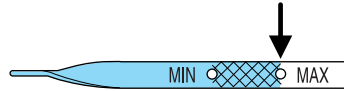

**An overfill condition of transmission fluid may cause shift and/or engagement concerns and/or possible damage.**

Do not use supplemental transmission fluid additives, treatments or cleaning agents. The use of these materials may affect transmission operation and result in damage to internal transmission components.

### Checking and adding manual transmission fluid (if equipped)

1. Clean the filler plug.
2. Remove the filler plug and inspect the fluid level.
3. Fluid level should be at the bottom of the opening.
4. Add enough fluid through the filler opening so that the fluid level is at the bottom of the opening.
5. Install and tighten the fill plug securely.

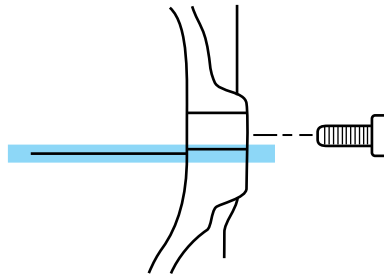

Use only fluid that meets Ford specifications. Refer to the *Maintenance product specifications and capacities* section in this chapter.

### AIR FILTER

Refer to *scheduled maintenance information* for the appropriate intervals for changing the air filter element.

When changing the air filter element, use only the Motorcraft air filter element listed. Refer to *Motorcraft part numbers* in this chapter.

**WARNING:** To reduce the risk of vehicle damage and/or personal burn injuries do not start your engine with the air cleaner removed and do not remove it while the engine is running.

## Maintenance and Specifications

### Air filter element (PZEV)

Your vehicle is equipped with a long life air filter. The air filter is designed to last the life of the vehicle. See your authorized dealer or a qualified technician for replacement. The technician can check the diagnostics system for the possibility of an excessively dirty air filter.

### Changing the air filter element (Non-PZEV only)

1. Release the clamps that secure the air filter housing cover.
2. Carefully separate the two halves of the air filter housing.
3. Remove the air filter element from the air filter housing.
4. Wipe the air filter housing and cover clean to remove any dirt or debris and to ensure good sealing.
5. Install a new air filter element. Be careful not to crimp the filter element edges between the air filter housing and cover. This could cause filter damage and allow unfiltered air to enter the engine if not properly seated.
6. Replace the air filter housing cover and secure the clamps. Be sure that the air cleaner cover tabs are engaged into the slots of the air cleaner housing.

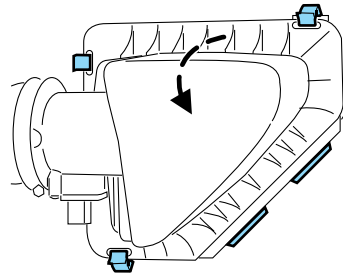

**Note:** Failure to use the correct air filter element may result in severe engine damage. The customer warranty may be void for any damage to the engine if the correct air filter element is not used.

## Maintenance and Specifications

### MOTORCRAFT PART NUMBERS

Component	2.0L I4 engine
Air filter element	FA-1890 <sup>1</sup>
Oil filter	FL-910 <sup>2</sup>
Battery	BXT-96R
Temporary mobility kit refill canister	TA-33
PCV valve	<sup>3</sup>
Spark plugs	<sup>4</sup>

<sup>1</sup>Non PZEV only: Failure to use the correct air filter element may result in severe engine damage. The customer warranty may be void for any damage to the engine if the correct air filter element is not used.

For PZEV, the air filter is designed to last the life of the vehicle. See your authorized dealer or qualified technician for replacement. The technician can check the diagnostics system for the possibility of an excessively dirty air filter.

<sup>2</sup>Only use the specified replacement oil filter. The use of a non-specified oil filter can result in engine damage.

<sup>3</sup>The PCV valve is a critical emission component. It is one of the items listed in *scheduled maintenance information* and is essential to the life and performance of your vehicle and to its emissions system.

For PCV valve replacement, see your authorized dealer. Refer to *scheduled maintenance information* for the appropriate intervals for changing the PCV valve.

**Replace the PCV valve with one that meets Ford material and design specifications for your vehicle, such as a Motorcraft or equivalent replacement part. The customer warranty may be void for any damage to the emissions system if such a PCV valve is not used.**

<sup>4</sup>For spark plug replacement, see your authorized dealer. Refer to *scheduled maintenance information* for the appropriate intervals for changing the spark plugs.

**Replace the spark plugs with ones that meet Ford material and design specifications for your vehicle, such as Motorcraft or equivalent replacement parts. The customer warranty may be void for any damage to the engine if such spark plugs are not used.**

## Maintenance and Specifications

### MAINTENANCE PRODUCT SPECIFICATIONS AND CAPACITIES

Item	Capacity	Ford Part Name or Equivalent	Ford Part Number / Ford Specification
Brake fluid (and clutch fluid—if equipped)	Between MIN and MAX on reservoir	Motorcraft High Performance DOT 3 Motor Vehicle Brake Fluid	PM-1-C / WSS-M6C62-A or WSS-M6C65-A1
Door latch, hood latch, auxiliary hood latch, trunk latch, seat tracks.	—	Multi-Purpose Grease	XG-4 or XL-5 / ESB-M1C93-B
Lock cylinder	—	Motorcraft Penetrating and Lock Lubricant	XL-1 / None
Automatic transmission fluid	6.9 quarts (6.6L) <sup>1</sup>	Motorcraft MERCON® LV ATF <sup>2</sup>	XT-10-QLV / MERCON® LV
Manual transmission fluid (5-speed)	2.0 quarts (1.9L) <sup>1</sup>	Motorcraft Full Synthetic Manual Transmission Fluid	XT-M5-QS / WSD-M2C200-C
Engine oil	4.5 quarts (4.3L)	Motorcraft SAE 5W-20 Premium Synthetic Blend Motor Oil (US) Motorcraft SAE 5W-20 Super Premium Motor Oil (Canada) <sup>3</sup>	XO-5W20-QSP (US) CXO-5W20-LSP12 (Canada) / WSS-M2C930-A and API Certification Mark
Engine coolant	6.1 quarts (5.75L)	Motorcraft Premium Gold Engine Coolant with bittering agent (yellow-colored) <sup>4</sup>	VC-7-B / WSS-M97B51-A1

## Maintenance and Specifications

Item	Capacity	Ford Part Name or Equivalent	Ford Part Number / Ford Specification
Cooling system stop leak pellets	—	Motorcraft Cooling System Stop Leak Pellets	VC-6 / WSS-M99B37-B6
Power steering fluid	Fill to between MIN and MAX lines on reservoir	Motorcraft MERCON® V ATF	XT-5-QM / MERCON® V
Windshield washer fluid	Top-off as needed	Motorcraft Premium Windshield Washer Concentrate	ZC-32-A / WSB-M8B16-A2
Fuel tank	13.0 gallons (49.2L)	—	—

<sup>1</sup>Approximate dry fill capacity including transmission fluid cooling system, actual refill capacities will vary based on vehicle application and transmission fluid cooling system (i.e. cooler size, cooling lines, auxiliary cooler capacities). The amount of transmission fluid and fluid level should be set by the indication on the dipstick's normal operating range.

The manual transmission service refill capacity is determined by filling the transmission to the bottom of the filler hole with the vehicle on a level surface.

<sup>2</sup>Automatic transmissions that require MERCON® LV should only use MERCON® LV fluid. Refer to *scheduled maintenance* to determine the correct service interval. Use of any fluid other than the recommended fluid may cause transmission damage.

<sup>3</sup>Use of synthetic or synthetic blend motor oil is not mandatory. Engine oil need only meet the requirements of Ford specification WSS-M2C930-A and the API Certification mark.

<sup>4</sup>Add the coolant type originally equipped in your vehicle.

## Maintenance and Specifications

### ENGINE DATA

Engine	2.0L I4 engine
Cubic inches	121
Required fuel	87 octane
Firing order	1-3-4-2
Ignition system	C.O.P
Compression ratio	10.0:1
Spark plug gap	.051 inch +/- .002 (1.3 mm +/- .05)

## Maintenance and Specifications

### Engine drivebelt routing

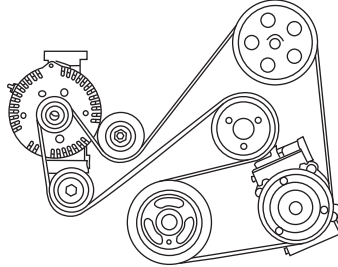

### IDENTIFYING YOUR VEHICLE

#### Safety Compliance Certification Label

The National Highway Traffic Safety Administration Regulations require that a Safety Compliance Certification Label be affixed to a vehicle and prescribe where the Safety Compliance Certification Label may be located. The Safety Compliance Certification Label is located on the structure (B-Pillar) by the trailing edge of the driver's door or the edge of the driver's door.

MFD. BY FORD MOTOR CO.					
DATE: XX/XX	GVWR: XXXXXLB/ XXXXXKG				
FRONT GAWR: XXXXL	REAR GAWR: XXXXLB				
XXXXKG	WITH	XXXXKG	WITH		
XXXX/XXXXXX	TIRES	XXXX/XXXXXX	TIRES		
XXXX XX	RIMS	XXXX XX	RIMS		
AT XXX kPa/XX	PSI COLD	AT XXX kPa/XX	PSI COLD		
THIS VEHICLE CONFORMS TO ALL APPLICABLE FEDERAL MOTOR VEHICLE SAFETY AND THEFT PREVENTION STANDARDS IN EFFECT ON THE DATE OF MANUFACTURE SHOWN ABOVE.					
VIN: XXXXXXXXXXXXXXXXX	XXXXX		XXXXX		
TYPE: XXX					
EXT PNT: XX	RC: XX	DSO:			
WB <sup>1</sup> BRK <sup>1</sup> INT TR <sup>1</sup> TP/PS <sup>1</sup> R <sup>1</sup> AXLE <sup>1</sup> TR <sup>1</sup> SPR <sup>1</sup> XXXXX					
XXX X XX X XX X XX XXX					
XXXXXXXXXXXXX XXX XXXX-XXXXXX-XX					

## Maintenance and Specifications

### Vehicle identification number (VIN)

The vehicle identification number is located on the driver side instrument panel.

Please note that in the graphic, XXXX is representative of your vehicle identification number.

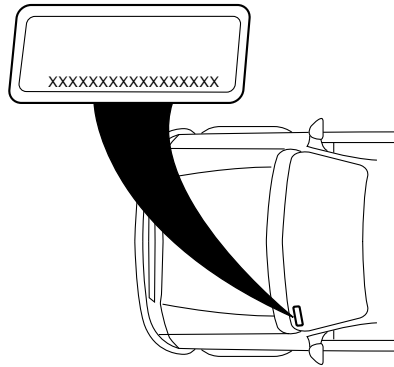

The Vehicle Identification Number (VIN) contains the following information:

1. World manufacturer identifier
2. Brake system / Gross Vehicle Weight Rating (GVWR) / Restraint System
3. Vehicle line, series, body type
4. Engine type
5. Check digit
6. Model year
7. Assembly plant
8. Production sequence number

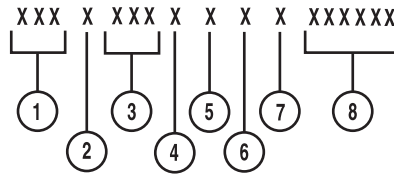



## Maintenance and Specifications

### TRANSMISSION CODE DESIGNATIONS

You can find a transmission code on the Safety Compliance Certification Label. The following table tells you which transmission each code represents.

MFD. BY FORD MOTOR CO.									
DATE: XX/XX	GVWR: XXXXXLB/ XXXXXKG								
FRONT GAWR: XXXXL	WITH XXXXKG		REAR GAWR: XXXXLB		WITH XXXXKG				
XXXXXX	TIRES: XXXX/XXXXXX		XXXXXX		TIRES XXXX/XXXXXX				
XXXXXX	RIMS: XXXX XX		XXXXXX		RIMS XXXX XX				
AT XXX kPa/XX	PSI COLD		AT XXX kPa/XX		PSI COLD				
THIS VEHICLE CONFORMS TO ALL APPLICABLE FEDERAL MOTOR VEHICLE SAFETY AND THEFT PREVENTION STANDARDS IN EFFECT ON THE DATE OF MANUFACTURE SHOWN ABOVE.									
VIN: XXXXXXXXXXXXXXXXX									XXXXX
TYPE: XXX									XXXXX
									
EXT PNT: XX	RC: XX		DSO:						
WB <sup>1</sup> BRK <sup>2</sup>	INT TR <sup>3</sup>	TP/PS <sup>4</sup>	R <sup>5</sup>	AXLE <sup>6</sup>	TR <sup>7</sup>	SPR <sup>8</sup>	XXXXX		
XXX X	XX	X	XX	X	XX	XX	XXX		
XXXXXXXXXXXX XX XXXX-XXXXXX-XX									

Description	Code
Four-speed automatic (4F27E)	2
Five-speed manual (MTX75)	Z

## Accessories

### GENUINE FORD ACCESSORIES FOR YOUR VEHICLE

A wide selection of Genuine Ford Accessories are available for your vehicle through your local Ford or Ford of Canada dealer. These quality accessories have been specifically engineered to fulfill your automotive needs; they are custom designed to complement the style and aerodynamic appearance of your vehicle. In addition, each accessory is made from high quality materials and meets or exceeds Ford's rigorous engineering and safety specifications. Ford Motor Company will repair or replace any properly dealer-installed Genuine Ford Accessories found to be defective in factory-supplied materials or workmanship during the warranty period, as well as any component damaged by the defective accessories. The accessories will be warranted for whichever provides you the greatest benefit:

- 12 months or 12,000 miles (20,000 km) (whichever occurs first), or
- the remainder of your new vehicle limited warranty.

Contact your dealer for details and a copy of the warranty.

The following is a list of several Genuine Ford Accessories. Not all accessories are available for all models. For a complete listing of the accessories that are available for your vehicle, please contact your dealer or visit our online store at: [www.fordaccessories.com](http://www.fordaccessories.com).

#### Exterior style

Bug shields

Chrome exhaust tips

Deflectors

Exterior trim kits

Fog lights

Splash guards

Wheels

#### Interior style

Electrochromatic compass/temperature interior mirrors

Floor mats

#### Lifestyle

Ash cup / smoker's package

Cargo organization and management

258

<https://www.MyCarManual.com>

## Accessories

### Peace of mind

Mobile-Ease™ hands free communication system

Remote start

Vehicle security systems

Wheel locks

For maximum vehicle performance, keep the following information in mind when adding accessories or equipment to your vehicle:

- When adding accessories, equipment, passengers and luggage to your vehicle, do not exceed the total weight capacity of the vehicle or of the front or rear axle (GVWR or GAWR as indicated on the Safety Compliance Certification label). Consult your authorized dealer for specific weight information.
- The Federal Communications Commission (FCC) and Canadian Radio Telecommunications Commission (CRTC) regulate the use of mobile communications systems — such as two-way radios, telephones and theft alarms - that are equipped with radio transmitters. Any such equipment installed in your vehicle should comply with FCC or CRTC regulations and should be installed only by a qualified service technician.
- Mobile communications systems may harm the operation of your vehicle, particularly if they are not properly designed for automotive use.
- To avoid interference with other vehicle functions, such as anti-lock braking systems, amateur radio users who install radios and antennas onto their vehicle should not locate the Amateur Radio Antennas in the area of the driver's side hood.
- Electrical or electronic accessories or components that are added to the vehicle by the authorized dealer or the owner may adversely affect battery performance and durability.

## Index

### A

AdvanceTrac .....172  
Air cleaner filter .....249–251  
Air conditioning  
  manual heating and air  
  conditioning system .....36  
Airbag supplemental restraint  
system .....102–103, 111, 114  
  and child safety seats .....104  
  description .....103, 111, 114  
  disposal .....117  
  driver airbag .....105, 112, 115  
  indicator light .....111, 116  
  operation .....105, 112, 115  
  passenger airbag .....105, 112, 115  
  side airbag .....111  
Ambient mood/lighting .....43  
AM/FM .....19  
Antifreeze  
(see Engine coolant) .....229  
Anti-lock brake system  
(see Brakes) .....169  
Anti-theft system .....78  
Audio system (see Radio) .....19  
Automatic transaxle  
  fluid, adding .....247  
  fluid, checking .....247  
  fluid, specification .....252  
Automatic transmission .....177  
  driving an automatic  
  overdrive .....178  
  fluid, refill capacities .....252  
Auxiliary input jack  
(Line in) .....27  
Axle  
  refill capacities .....252

### B

Battery .....227  
  acid, treating emergencies .....227  
  jumping a disabled battery .....198  
  maintenance-free .....227  
  replacement, specifications .....251  
  servicing .....227  
Belt-Minder® .....98  
Booster seats .....134  
Brakes .....168–169  
  anti-lock .....169  
  anti-lock brake system (ABS)  
  warning light .....169  
  fluid, checking and adding .....247  
  fluid, refill capacities .....252  
  fluid, specifications .....252  
  lubricant specifications .....252  
  parking .....170  
  shift interlock .....177  
Break-in period .....6  
Bulbs .....43

### C

Capacities for refilling fluids .....252  
CD .....19  
Cell phone use .....9  
Child safety seats .....123  
  attaching with tether  
  straps .....132  
  in front seat .....123, 127  
  in rear seat .....123, 127  
  LATCH .....129  
  recommendations .....120  
Child safety seats - booster  
seats .....134

## Index

- Cleaning your vehicle
    - engine compartment .....215
    - instrument panel .....216
    - interior .....217
    - plastic parts .....215
    - washing .....213
    - waxing .....214
    - wheels .....214
    - wiper blades .....216
  - Climate control (see Air conditioning or Heating) .....36
  - Clutch
    - fluid .....247
    - operation while driving .....180
    - recommended shift speeds ....181
  - Compass, electronic .....49
    - calibration .....50
    - set zone adjustment .....50
  - Console .....51
  - Controls
    - steering column .....57
  - Coolant
    - checking and adding .....229
    - refill capacities .....233, 252
    - specifications .....252
  - Cruise control (see Speed control) .....54
  - Customer Assistance .....183
    - Ford Extended Service Plan .....209
    - Getting assistance outside the U.S. and Canada .....210
    - Getting roadside assistance .....183
    - Getting the service you need .....205
    - Ordering additional owner's literature .....211
    - Utilizing the Mediation/Arbitration Program .....209
- D**
- Daytime running lamps (see Lamps) .....40
  - Dipstick
    - automatic transmission fluid .....247
    - engine oil .....225
  - Driving under special conditions
    - .....180
    - through water .....182
- E**
- Electronic message center .....60
  - Emergencies, roadside
    - jump-starting .....198
  - Emergency Flashers .....185
  - Emission control system .....243
  - Engine .....254–255
    - cleaning .....215
    - coolant .....229
    - fail-safe cooling .....233
    - idle speed control .....227
    - lubrication specifications .....252
    - refill capacities .....252
    - service points .....223–224
    - starting after a collision .....185
  - Engine block heater .....167
  - Engine fan .....223
  - Engine oil .....225
    - change oil soon warning, message center .....225
    - checking and adding .....225
    - dipstick .....225

## Index

- filter, specifications .....226, 251
- recommendations .....226
- refill capacities .....252
- specifications .....252
- Event data recording .....7
- Exhaust fumes .....166
  
- F**
- Fail safe cooling .....233
- Fan, Engine Cooling .....220, 223
- Floor mats .....67
- Fluid capacities .....252
- Fog lamps .....39
- Fuel .....235
  - calculating fuel
  - economy .....61, 240
  - cap .....237
  - capacity .....252
  - choosing the right fuel .....238
  - comparisons with EPA fuel
  - economy estimates .....243
  - detergent in fuel .....239
  - filling your vehicle
  - with fuel .....235, 237, 240
  - filter, specifications .....235, 251
  - fuel pump shut-off switch .....185
  - improving fuel economy .....240
  - octane rating .....239, 254–255
  - quality .....239
  - running out of fuel .....240
  - safety information relating to
  - automotive fuels .....235
- Fuel pump shut-off switch .....185
- Fuses .....186–187
  
- G**
- Gas cap (see Fuel cap) .....237
- Gas mileage  
(see Fuel economy) .....240
- Gauges .....17
  
- H**
- Hazard flashers .....185
- Head restraints .....81
- Headlamps .....39
  - aiming .....41
  - bulb specifications .....44
  - daytime running lights .....40
  - flash to pass .....40
  - high beam .....39
  - replacing bulbs .....44
  - turning on and off .....39
- Heating
  - heating and air conditioning
  - system .....36
- Hood .....221
  
- I**
- Ignition .....163, 254–255
- Infant seats  
(see Safety seats) .....123
- Inspection/maintenance (I/M)  
testing .....245
- Instrument panel
  - cleaning .....216
  - cluster .....12
  - lighting up panel and
  - interior .....40

## Index

### J

Jump-starting your vehicle .....198

### K

Keyless entry system  
  autolock .....68

Keys .....79  
  positions of the ignition .....163

### L

Lamps  
  bulb replacement  
  specifications chart .....44  
  daytime running light .....40  
  fog lamps .....39  
  headlamps .....39  
  headlamps, flash to pass .....40  
  instrument panel, dimming .....40  
  interior lamps .....42, 44  
  replacing bulbs .....44

LATCH anchors .....129

Lights, warning and indicator ....12  
  anti-lock brakes (ABS) .....169

Load limits .....157

Locks  
  autolock .....68  
  childproof .....72  
  doors .....68

Lubricant specifications .....252

Lug nuts .....197

### M

Manual transaxle  
  lubricant specifications .....252

Manual transmission .....180  
  fluid capacities .....252  
  reverse .....181

Message center .....60–61  
  english/metric button .....63  
  system check button .....63  
  warning messages .....64

Mirrors .....53–54  
  automatic dimming rearview  
  mirror .....53  
  heated .....54  
  side view mirrors (power) .....54

Moon roof .....59

Motorcraft parts .....219, 251

### O

Octane rating .....239

Oil (see Engine oil) .....225

### P

Parking brake .....170

Parts (see Motorcraft parts) ....251

Passenger Occupant  
  Classification Sensor .....90

Power distribution box  
  (see Fuses) .....189

Power door locks .....68

Power mirrors .....54

Power point .....51

Power steering .....176  
  fluid, checking and adding ....246  
  fluid, refill capacity .....252  
  fluid, specifications .....252

Power Windows .....52

263

<https://www.MyCarManual.com>

## Index

### R

- Radio .....19
- Recommendations for attaching safety restraints for children .....120
- Relays .....186
- Remote entry system .....74
  - locking/unlocking doors ....74–75
  - opening the trunk .....76
  - panic alarm .....75
  - replacement/additional transmitters .....77
  - replacing the batteries .....76
- Roadside assistance .....183

### S

- Safety belts (see Safety restraints) ...89, 92–97
- Safety Canopy .....111
- Safety defects, reporting .....211–212
- Safety restraints .....89, 92–97
  - Belt-Minder® .....98
  - extension assembly .....98
  - for adults .....93–96
  - for children .....118
  - Occupant Classification Sensor .....90
  - warning light and chime .....98
- Safety restraints - LATCH anchors .....129
- Safety seats for children .....123
- Safety Compliance Certification Label .....255
- Satellite Radio (if equipped) ....19
- Satellite Radio Information .....32

- Seats .....81
    - child safety seats .....123
    - heated .....86
  - SecuriLock passive anti-theft system .....78
  - Servicing your vehicle .....220
  - Side air curtain .....114
  - Spark plugs, specifications .....251, 254–255
  - Specification chart, lubricants .....252
  - Speed control .....54
  - Starting your vehicle .....163–164, 166
    - jump starting .....198
  - Steering wheel
    - controls .....57
    - tilting .....49
  - Stereo
    - CD-MP3 .....19
  - SYNC® .....35
- ### T
- Tilt steering wheel .....49
  - Tire Pressure Monitoring System (TPMS)
    - Tires, Wheels and Loading ....152
  - Tires .....138–139
    - alignment .....146
    - care .....142
    - changing .....194
    - checking the pressure .....142
    - inflating .....140
    - label .....152
    - replacing .....144
    - rotating .....146
    - safety practices .....145



## Index

- sidewall information .....147
  - snow tires and chains .....157
  - spare tire .....192
  - terminology .....139
  - tire grades .....139
  - treadwear .....138, 143
  - Towing .....161
    - recreational towing .....162
    - trailer towing .....161
    - wrecker .....203
  - Traction control .....170
  - Transaxle
    - lubricant specifications .....252
  - Transmission
    - automatic operation .....177
    - brake-shift interlock (BSI) ....177
    - fluid, checking and adding
      - (automatic) .....247
      - fluid, checking and adding
        - (manual) .....249
      - fluid, refill capacities .....252
      - manual operation .....180
  - Trunk .....72
    - remote release .....76
  - Turn signal .....42
- U**
- USB port .....29
- V**
- Vehicle Identification Number (VIN) .....256
  - Vehicle loading .....157
  - Ventilating your vehicle .....166
- W**
- Warning lights (see Lights) .....12
  - Washer fluid .....224
  - Water, Driving through .....182
  - Windows
    - power .....52
  - Windshield washer fluid and wipers .....48
    - checking and adding fluid ....224
    - replacing wiper blades .....224
  - Wrecker towing .....203